

DETAIL "Y"

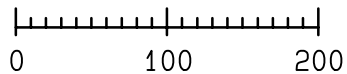

suitable up to a moment of inertia of 0.04 kgm²
 geeignet bis zu einem Massenträgheitsmoment von 0.04 kgm²
 Anzugsmoment von 80 Nm
 tightening torque of 80 Nm

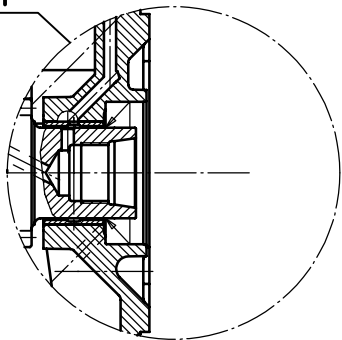
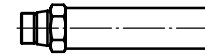

05107302.1003 / SW 27
 Rohwelle
 raw shaft

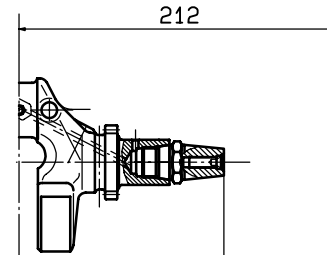

05099701.1003
 ital-keg-23ø

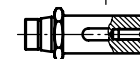

05127802.1013
 zyl.-25ø



05127722.1013
 SAE-pump Ø1"-14 UNS 2A

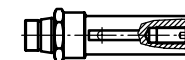

05127621.1013
 zyl.-Ø1"

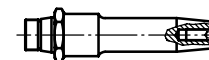

05127402.1013
 SAE-Gen.

In the interests of technical progress we reserve the right to introduce modifications.
 Änderungen, die dem technischen Fortschritt dienen, behalten wir uns vor.

The range of the length over-all based on tolerances can add up to ± 3 mm
 Toleranzbedingte Streubreite bei Kastenmassen ± 3 mm

PROTECTION MARK
 ACC. TO DIN 34



Schutzvermerk nach
 DIN 34 beachten



INSTALLATION DRAWING
 Einbauzeichnung

1B30

SHAFTS AT GOVERNOR-SIDE
 Wellen auf sts.

SHEET OF SHEETS
 Blatt 10 von 10 Blättern

gez.: 17.01.06 Gerh gepr.: 17.01.06 Gerh