

CREATING POWER SOLUTIONS.

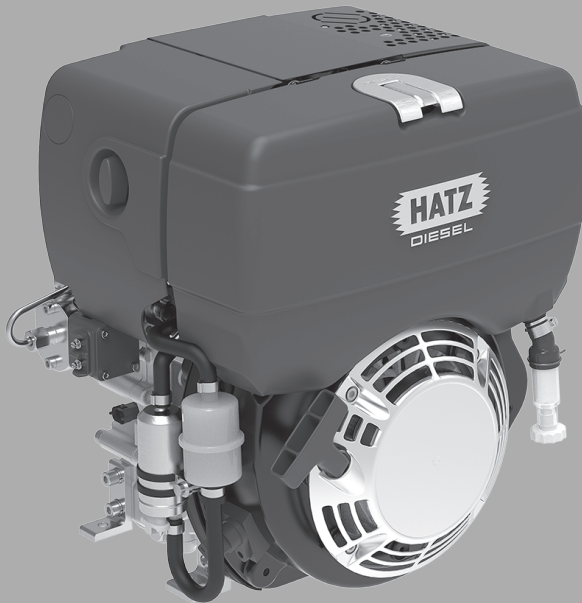

1B30E | 1B50E

MANUAL for diesel engine

Hatz Diesel

www.hatz-diesel.com

1	Legal notices	5
2	General information	6
3	Safety	7
3.1	General information.....	7
3.1.1	Intended use	7
3.1.2	Machine user or machine manufacturer obligations	8
3.1.3	Representation of safety notes	9
3.1.4	Meaning of safety symbols.....	10
3.2	Safety notes	12
3.2.1	Operational safety	12
3.2.2	Machine-specific safety instructions for operation	15
3.2.3	Machine-specific safety instructions for maintenance work	16
3.2.4	Electrical equipment.....	18
3.3	Labels.....	20
4	Technical data	21
4.1	Engine information and filling quantities	21
4.2	Engine type plate	23
4.2.1	Engine serial number	24
4.3	Engine oil	24
4.4	Fuel	25
5	Engine overview	27
5.1	Designation of components.....	27
5.2	HATZ instrument box	30
6	Transport, installation and commissioning	33
6.1	Transport.....	33
6.2	Installation notes	35
6.3	Preparations for commissioning.....	36
6.4	Filling engine oil (first filling).....	36
6.5	Venting the fuel system.....	37
7	Operation and use	40
7.1	Safety notes	40
7.2	Performing tests	41
7.3	Starting the engine	41
7.4	Switching off the engine	44
7.5	Check the oil level	46
7.6	Refueling.....	48
7.7	Checking the water separator	50
7.8	Check the air filter warning indicator (option).....	52

8	Maintenance	53
8.1	General maintenance instructions.....	53
8.2	Maintenance work.....	54
8.2.1	Maintenance notice label	54
8.2.2	Maintenance plan.....	55
8.2.3	Checking the intake area	57
8.2.4	Change the engine oil	58
8.2.5	Clean the oil filter	61
8.2.6	Checking and setting the tappet clearance.....	64
8.2.7	Cleaning the cooling air area	67
8.2.8	Check the screw connections	70
8.2.9	Clean the exhaust screen	70
8.2.10	Changing the fuel filter	72
8.2.11	Maintaining the dry air filter.....	75
8.2.12	Checking and cleaning the air filter cartridge.....	77
9	Faults	79
9.1	Troubleshooting	79
9.2	Flash code table for engine faults	83
9.3	Start support.....	86
9.4	Emergency hand start.....	89
10	Storage and disposal	94
10.1	Storing the machine	94
10.2	Disposing of the machine.....	96
11	Declaration of incorporation.....	97
12	Declaration of the manufacturer	98

1 Legal notices

Contact data

© 2024
 Motorenfabrik Hatz
 Ernst-Hatz-Straße 16
 94099 Ruhstorf
 Germany
 Tel. +49 (0)8531 319-0
 Fax +49 (0)8531 319-418
 marketing@hatz-diesel.de
 www.hatz-diesel.com
 All rights reserved!

Copyright

The copyright for this manual rests entirely with Motorenfabrik HATZ, Ruhstorf.

This manual may only be copied or distributed if written approval has been received. This also applies to the copying or distribution of excerpts of this manual. The same conditions apply to distribution of this manual to third parties in digital form.

Original manual

This manual has been translated into multiple languages.

The German version is the **original manual**. All other language versions are **translations** of the **original manual**.

Revision

Version	Date	Name
02 - Rev. 01	23.11.2022	GMV / ef
03 - Rev. 00	14.12.2023	GMV / ef

2 General information

Information on the document

This manual was created with due care. It is exclusively intended to offer a technical description of the machine and to provide instructions on commissioning, operating and maintaining the machine. When operating the machine, the applicable standards and legal regulations as well as any in-house regulations apply.

Before commissioning, during operation and before maintenance work is begun on the machine, read this manual carefully and keep it close by for ready access.

Machine

This manual describes the following machine.

Machine name	HATZ diesel engine
Type number	1B30E, 1B50E

Customer service

Have service work performed by qualified technicians only. We recommend that you work with one of the over 500 **HATZ service stations**. Trained specialists there will repair your machine with **Hatz original spare parts** and with **HATZ tools**. The global HATZ service network is at your disposal to advise you and supply you with spare parts. For the address of the **Hatz service station** nearest you, please see the enclosed spare parts list or visit us in the Internet at: **www.hatz-diesel.com**

Installation of unsuitable spare parts can lead to problems. We cannot accept liability for direct damage or secondary damage that results from this.

We therefore recommend the use of **Hatz original spare parts**. These parts are manufactured according to strict Hatz specifications and achieve maximum operational reliability through their perfect fit and functionality. The order number can be found in the enclosed spare parts list or on the Internet at: **www.hatz-diesel.com**

Exclusion of liability

The manufacturer cannot be held liable for personal injury, damage to property or damage to the machine itself caused by improper use, foreseeable misuse, or failure to follow or adequately follow the safety measures and procedures described in this manual. This also applies to changes made to the machine and the use of unsuitable spare parts.

Modifications, which serve the technical improvements, are reserved.

3 Safety

3.1 General information

Introduction

This chapter contains the information you need to work safely with this machine.

To prevent accidents and damage to the machine, it is imperative that these safety instructions be followed.

Read this chapter carefully before beginning work.

3.1.1 Intended use

Intended use

The machine described in this manual fulfills the following functions:

- Diesel engine intended for installation in a machine or for assembly with other machines to form a machine. See chapter *11 Declaration of incorporation, page 97*.

This engine is intended exclusively for the purpose specified and tested by the manufacturer of the machine in which the engine is installed.

Any other use is not intended and therefore not permitted. Violations compromise the safety of the personnel working with the machine. Motorenfabrik HATZ does not accept any liability for damage resulting from this.

The operational safety of the machine is only guaranteed if it is used as intended.

Use according to the intended purpose also includes observance of the instructions in this Operator's Manual

Foreseeable misuse

The following is considered to be foreseeable misuse:

- Any use that varies from or extends beyond the uses specified above.
- Failure to comply with the instructions given in this manual.
- Failure to comply with the safety instructions.
- Failure to immediately eliminate malfunctions that impact safety before continuing work with the machine (working with the machine when it is not in perfect condition, either functionally or in terms of safety).
- Failure to perform the necessary inspection and maintenance work.
- Any unauthorized modification of or removal of safety equipment.
- Use of spare parts and accessories that are unsuitable or have not been approved by HATZ.
- Fuel other than specified in the instructions.
- Operation in flammable or hazardous environments.

- Operation in closed-off or poorly ventilated rooms.
- Operation in an aggressive atmosphere (e.g., high salt content) without further measures for corrosion protection.
- Improper operation at variance with DIN ISO 3046 -1 and DIN ISO 8528 (climate, load, safety).

Residual risks

Residual risks result during daily use and in association with maintenance work.

These residual risks will be pointed out in chapter 3.2.2 *Machine-specific safety instructions for operation, page 15* and in chapter 3.2.3 *Machine-specific safety instructions for maintenance work, page 16* as well as in the further contents of the manual, directly in front of the descriptions or operating instructions concerned.

3.1.2 Machine user or machine manufacturer obligations

Machine manufacturer obligations

If you have an engine that is not yet installed in a machine, it is imperative that you follow the **Assembly Instructions for HATZ Diesel Engines** before installing the engine. These assembly instructions contain important information on how to safely install the engine and are available at your nearest **HATZ service station**.

It is prohibited to start the engine before it is fully installed.

In addition, please note that it is prohibited to start up the machine before it has been determined that the machine into which this engine is installed fulfills all safety-related requirements and legal regulations.

User obligations

The operator is obliged to only operate the machine when it is in perfect condition. The operator must check the condition of the machine before use and ensure that any defects are eliminated before it is taken into service. Running the machine while identified defects exist is not permitted. The operator must also ensure that all persons who work on the machine are familiar with the contents of this manual, .

Obligations of the operating and maintenance personnel

Personnel assigned with operating and maintaining the machine must have read and understood this manual or must possess the qualifications necessary for working with this equipment, acquired in training/instructional courses. No one may work with the machine without the necessary qualifications, even if for just a brief period.

The operating and maintenance personnel must not be under the influence of drugs, medication or alcohol.

All work performed on the machine must be in compliance with the information provided in this manual.

Storing this manual

This manual is an integral component of the machine (also when being sold). It must be stored in the direct vicinity of the machine and be accessible to personnel at all times.

3.1.3 Representation of safety notes

Overview

This machine has been designed and built according to state-of-the-art technology and the recognized safety standards. Despite these precautions, risks exist when operating the machine and during maintenance work.

These risks are identified in this manual by means of safety notes.

The safety notes precede the relevant description or operating step.

Structure of the safety notes

The safety notes consist of:

- Danger symbol
- Signal word
- Description of the danger
- Possible consequences
- Preventative measures



General danger symbol



The general danger symbol is used to identify the danger of personal injury.

Signal words





Signal words identify the magnitude of the risk and the seriousness of possible injury:









Danger symbol/ signal word	Meaning
 DANGER	This signal word is used to indicate imminently dangerous situations which, if not avoided, will lead to serious injury or death.
 WARNING	This signal word is used to indicate potentially dangerous situations which, if not avoided, may lead to serious injury or death.
 CAUTION	This signal word is used to indicate potentially dangerous situations which, if not avoided, may lead to minor or moderate injury.
CAUTION	This signal word, without a danger symbol, is used to indicate the risk of property damage.
NOTICE	This signal word indicates additional useful information, such as operating tips and cross references.

3.1.4 Meaning of safety symbols

Explanation of symbols

The following table describes the meanings of the safety symbols used in this manual.

Symbol	Meaning
	Smoking, fire, and open flames are prohibited!
	Warning of personal injury!
	Warning of hot surfaces!
	Warning of hot surfaces! (Alternative)



Symbol	Meaning
	Warning of flammable substances!
	Warning of explosive substances!
	Warning of toxic engine exhaust!
	Warning of corrosive substances!
	Warning of heavy loads!
	Warning of environmental damage!
	Comply with this manual or additional documentation from other manufacturers or the operator.
	Additional information that is useful to the reader.

3.2 Safety notes

3.2.1 Operational safety

Introduction

This chapter contains all of the important safety instructions for personal protection and for safe and reliable operation. Additional, task-related safety instructions can be found at the beginning of each chapter.

 DANGER	
	<p>Danger to life, danger of injury or danger of property damage due to failure to comply with this manual and the safety instructions contained therein.</p> <ul style="list-style-type: none">▪ As the operator of the machine, you must ensure that all people working on the machine are familiar with the content of this manual.▪ Before working on the machine, read this manual carefully, paying special attention to the safety notes▪ Fulfill all required safety conditions before working on the machine.▪ Follow all general safety instructions as well as the specific task-related safety instructions contained in the individual chapters.

Using the machine







- Only operate the machine for the purposes described in chapter 3.1.1 *Intended use*, page 7.

Compliance with other regulations

- The applicable regulations of the relevant professional associations must be observed.
- Comply with the regulations concerning the minimum safety and health requirements for the use of work equipment by workers at work.
- In addition, local safety, accident prevention and environmental regulations also apply when operating the machine.

Personal protective equipment

During operation and maintenance of the machine, personal protective equipment must be available and must be used if necessary. The use of personal protective equipment is specified in the description of the operating steps.

Personal protective equipment	Pictogram	Function
Safety shoes		Safety shoes offer protection against: <ul style="list-style-type: none"> ▪ Slipping ▪ Falling objects
Hearing protection		Hearing protection offers protection against ear injuries due to excessive and constant noise.
Safety gloves		Safety gloves protect the hands against injury, e.g., from battery acid.
Safety goggles (with side protection)		Safety goggles protect the eyes from flying objects (e.g., dust particles, spraying liquids, spraying acid).
Fine dust mask		A fine dust mask protects the wearer against particulate pollutants.
Working clothes		Wear close-fitting working clothes. It must not restrict the wearer's freedom of movement, however.

Warning labels and information signs on the machine

The warning labels and information signs on the machine must be followed (see chapter "Labels" 3.3 *Labels*, page 20).

The warning labels and information signs must be kept legible and must be replaced if necessary. For this purpose, contact your nearest **HATZ service station**.

Maintenance work









Maintenance work that goes beyond the scope described in this manual must only be performed by qualified technicians (see chapter 2 *General information*, page 6).

Independent maintenance work and constructional changes to the machine, especially to the safety equipment, are not permitted.

Safety equipment

Safety equipment must not be modified and must not be rendered ineffective during normal operation.

General safety instructions

 DANGER	
	<p>Danger to life and danger of injury due to failure to follow the warnings on the machine and in this manual.</p> <ul style="list-style-type: none"> ▪ Heed the warnings on the machine and in this manual.
 WARNING	
	<p>Danger of injury and danger of incorrect operation due to inadequate personnel qualifications.</p> <ul style="list-style-type: none"> ▪ The personnel must have read and understood this manual or must possess the qualifications necessary for working with this equipment, acquired in training/instructional courses. ▪ Only qualified personnel is permitted to operate and maintain this machine. ▪ Failure to comply will cause the warranty to become void.
 WARNING	
	<p>Danger of injury from failure to follow the Operating Instructions and from performing unauthorized tasks on the machine.</p> <ul style="list-style-type: none"> ▪ Follow all instructions. ▪ Do not perform activities for which no qualification is available. Contact properly trained personnel if necessary.
 CAUTION	
	<p>Danger of injury from overloading the body.</p> <p>Lifting the machine to transport it or to move it to another location can lead to injuries (of the back, for example).</p> <ul style="list-style-type: none"> ▪ Only lift the machine with a hoist (see chapter 6.1 <i>Transport</i>, page 33).

3.2.2 Machine-specific safety instructions for operation

Introduction

The machine can pose residual risks during operation. To eliminate these risks, all persons working on the machine must follow the general and machine-specific safety instructions.

If you have an engine that is not yet installed in a machine, it is imperative that you follow the **Assembly Instructions for HATZ Diesel Engines** before installing the engine.

These Assembly Instructions contain important information on safe installation.

If the engine is installed in a machine or assembled with other machines to form a machine, it is prohibited to start the engine before it has been determined that the newly created machine fulfills all safety-related requirements and applicable legal regulations.



Safe operation







- Before switching on the machine, ensure that no one can be injured when the machine is started up.
- During machine operation, ensure that unauthorized persons do not have access to the area in which the machine has an impact.
- Parts of the exhaust gas system and the surface of the engine become hot during operation. Risk of injury from touching hot parts! Let the engine cool before maintenance.
- Do not refuel during operation.

Faults

- Immediately eliminate faults that compromise safety.
- Switch off the machine and do not take into service again until all faults have been eliminated.

Safety instructions for operation

 DANGER	
	<p>Danger to life from inhaling exhaust gases.</p> <p>Toxic engine exhaust gases can lead to loss of consciousness, and even death, in closed-off and poorly ventilated rooms.</p> <ul style="list-style-type: none"> ▪ Never operate the machine in closed-off or poorly ventilated rooms. ▪ Do not breathe in the exhaust gases.

 DANGER	
	<p>Danger of fire from hot exhaust gas system.</p> <p>If inflammable materials come into contact with the exhaust gas flow or the hot exhaust gas system, these materials can ignite.</p> <ul style="list-style-type: none"> ▪ Keep inflammable materials away from the exhaust gas system. ▪ Do not operate the engine (exhaust flow or hot exhaust gas system) in the direct vicinity of combustible materials.
 DANGER	
 	<p>Fire hazard from fuel.</p> <p>Leaked or spilled fuel can ignite on hot engine parts and cause serious burn injuries.</p> <ul style="list-style-type: none"> ▪ Only refuel when the engine is switched off and has cooled down. ▪ Never refuel in the vicinity of open flames or sparks that can cause ignition. ▪ Do not smoke. ▪ Do not spill fuel.
 CAUTION	
	<p>Danger of injury from faulty starter rope.</p> <p>A chafed starter rope can rip and cause injuries.</p> <ul style="list-style-type: none"> ▪ Before using the starter rope, check for abrasion; replace the rope if necessary.

3.2.3 Machine-specific safety instructions for maintenance work

Introduction

The machine can pose residual risks during maintenance. To eliminate these risks, all persons working on the machine must follow the general and machine-specific safety instructions.

Maintenance intervals

- Strictly adhere to the maintenance intervals.
- Check the safety equipment regularly to ensure it is in good condition and functioning properly.
- Check connections, cables and fasteners regularly to ensure they are in good condition.

Maintenance work

Maintenance work that goes beyond the scope described in this manual must only be performed by qualified technicians. We recommend that you work with one of the over 500 **HATZ service stations**.





Replacing parts





- When replacing defective components, we recommend that you use **Hatz original spare parts** (see chapter 2 *General information, page 6*).
- When disposing of parts that can no longer be used, do so in accordance with local environmental regulations or send them to a recycling center.

Measures following maintenance and troubleshooting

- Securely reconnect loose electrical connections; check that the electrical components and equipment are functioning properly.
- Check the entire machine for foreign bodies; remove any foreign bodies.



Safety instructions for maintenance work

 DANGER	
	<p>Danger of explosion from flammable cleaning agents.</p> <p>Cleaning with benzene is an explosion hazard. It is highly flammable, can become electrostatically charged, and can generate an explosive gas/air mixture.</p> <ul style="list-style-type: none"> ▪ Use halogen-free, cold cleaners with a high flash point for cleaning. ▪ Comply with manufacturer's instructions.
 WARNING	
 	<p>Danger of injury from compressed air and dust particles.</p> <p>Eye injuries can occur when cleaning with compressed air.</p> <ul style="list-style-type: none"> ▪ Wear safety goggles.

 CAUTION	
	<p>Danger of injury from ignoring the maintenance instructions.</p> <ul style="list-style-type: none"> ▪ Only perform maintenance work when the engine is switched off. ▪ Protect start-up devices (crank handle, recoil start or starting key) from unauthorized access. ▪ For engines with a starter: Disconnect the negative battery terminal. ▪ When the maintenance work has been completed, ensure that all tools are removed from the machine.
 CAUTION	
	<p>Danger of burns.</p> <p>There is a danger of burns when working on a hot engine.</p> <ul style="list-style-type: none"> ▪ Let the engine cool before maintenance.

3.2.4 Electrical equipment

Safety notes

 DANGER	
	<p>Danger to life, danger of injury or danger of property damage due to incorrect use of batteries.</p> <ul style="list-style-type: none"> ▪ Do not place tools or other metal objects on the battery. ▪ Before performing work on the electrical equipment, always disconnect the negative battery terminal. ▪ Never swap the plus (+) and negative (–) battery terminals. ▪ When installing the battery, first connect the plus cable and then the negative cable. ▪ When removing the battery, first disconnect the negative cable and then the plus cable. ▪ It is imperative to prevent short circuits and mass contact of current carrying cables. ▪ If faults occur, check the cable connections for good contact.

**DANGER****Danger of explosion from flammable substances.**

There is a danger of explosion from flammable gases.

- Keep batteries away from open flames and incendiary sparks.
- Do not smoke when working with batteries.

**CAUTION****Danger of chemical burns**

Chemical burns can occur when using batteries for the electrical operation.

- Protect your eyes, skin, and clothing from corrosive battery acid.
- Immediately rinse areas affected by splashed acid with clear water and consult a physician if necessary.

- Promptly replace defective indicator lamps.
- Do not disconnect the battery while the machine is running. Resulting voltage peaks could destroy the electronic components.
- When cleaning, do not spray the electrical equipment components with a water jet or high pressure cleaner.
- When performing welding work on the machine, disconnect the battery and place the ground clamp of the welding equipment as close as possible to the welding area. Disconnect the plug connectors to the engine control unit and to the voltage regulator of the alternator.

NOTICE

- We cannot be held liable for electrical equipment that is not designed according to HATZ wiring diagrams.

3.3 Labels

Warning labels and information signs on the engine

Label	Meaning
	<p>Maintenance instructions (see chapter 8.2 <i>Maintenance work</i>, page 54)</p>
	<p>Emergency hand start with recoil start (see chapter 9.4 <i>Emergency hand start</i>, page 89)</p>
	<p>CAUTION! Danger of injury from faulty starter rope. A chafed starter rope can rip and cause injuries.</p> <ul style="list-style-type: none"> Before using the starter rope, check for abrasion; replace the rope if necessary.
	<p>Refuel with diesel fuel only. For the specification, see chapter 4.4 <i>Fuel</i>, page 25.</p>

4 Technical data

4.1 Engine information and filling quantities

Type		1B30E	1B50E
Type		Air cooled, four stroke diesel engine	
Combustion system		Direct injection	
Number of cylinders		1	1
Bore/Stroke	mm	80 / 69	93 / 76
Displacement	cm ³	347	517
Tank capacity	Ltr.	5	5
Engine oil capacity			
Without oil sump	Approx. ltr.	1,1 ¹⁾	1.5 ¹⁾
With oil sump	Approx. ltr.	2,5 ¹⁾	3.2 ¹⁾
Difference between "max" and "min" marking			
Without oil sump	Approx. ltr.	0,5 ¹⁾	0.8 ¹⁾
With oil sump	Approx. ltr.	1,5 ¹⁾	2.2 ¹⁾
Engine oil consumption (after running-in period)	Max.	1 % of fuel consumption, pertaining to full load	
Engine oil pressure at oil temperature of 100 °C	Approx.	2.5 bar at 3000 rpm	
Sense of rotation on power take-off side		Left	
Tappet clearance at 10–30 °C inlet/outlet	mm	0.10	0.10
Weight (incl. fuel tank, air filter, silencer and electric start)	Approx. kg	41	58
Battery capacity	Max.	12 V – 55 Ah / 420 A (EN) / 450 A (SAE)	

¹⁾ These values are approximations only. The max. mark on the dipstick is decisive in any case (see chapter 7.5 *Check the oil level, page 46*).

Maximum permissible inclination during continuous operation *

Without additional oil pan

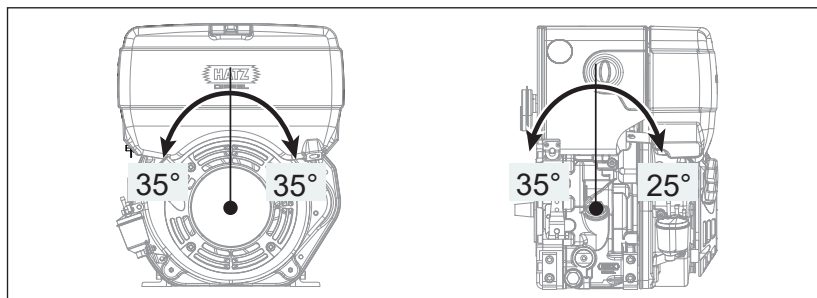

With additional oil pan

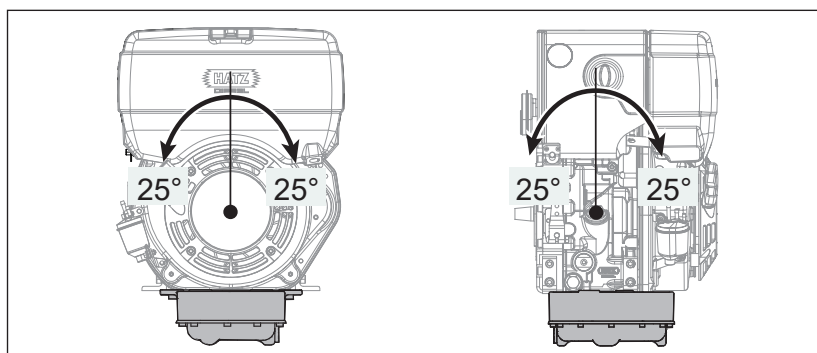

* Exceeding these limit values causes engine damage.

Engine specifications

Model	Description
T	Normal counter balance (1B50ET only)
U	Additional counter balance (1B50EU only)

Screw tightening torque

Designation	Nm
Oil drain screw	50

4.2 Engine type plate

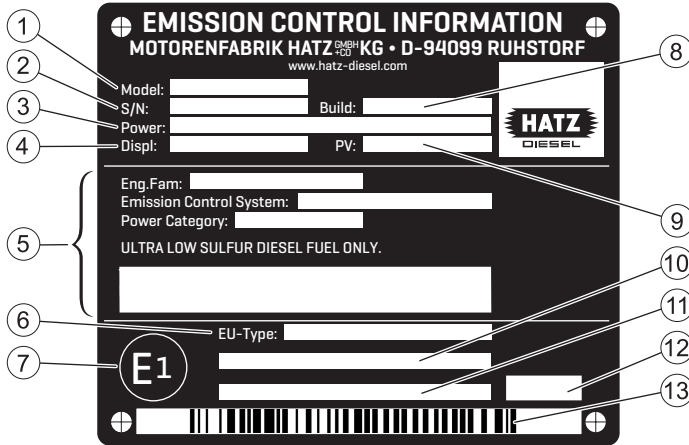

The engine type plate is located on the sound protection hood and contains the following engine information:

1	Model designation of the engine
2	Engine serial number
3	Engine power (kW) at rated speed (rpm)
4	Displacement (liters)
5	Information for US emission certification (EPA/CARB)
6	EU type approval number
7	EU country of origin (Germany)
8	Model year (month/year)
9	Test specification for special settings
10	Engine family designation or exemption code (EM) or transition code (TM) according to regulation (EU) 2016/1628
11	Additional specifications according to Regulation 2017/656 (exceptions) or "Separate shipment information"
12	Code for type plate variant
13	Barcode (engine serial number)

The following data must always be specified in case of queries and for spare parts orders:

1	Model designation
2	Engine serial number
3	Rated speed (rpm)

4.2.1 Engine serial number

Breakdown of the engine serial number

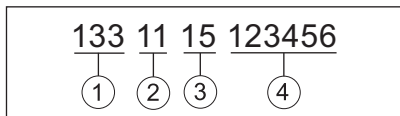

1	Engine type number
2	Engine serial number
3	Model year
4	Fabrication number (consecutive)

4.3 Engine oil

Oil quality

All oil brands that meet at least one of the following specifications are suitable:

- **ACEA E6 or E8** (recommended)
- **ACEA E9 or E11**
- **ACEA C3 / C4** (HTHS ≥ 3.5 mPas)
- **API CK-4 or CJ-4**

CAUTION	
	<p>Damage to the diesel oxidation catalyst (DOC) from using unsuitable engine oil.</p> <p>Unsuitable engine oil diminishes the functionality and service life of the catalytic converter.</p> <p>Only use engine oils with very low quantities of sulfate ash, phosphor and sulfur – so-called "low SAPS" oils which fulfill at least one of the specifications mentioned above.</p>

Oil viscosity

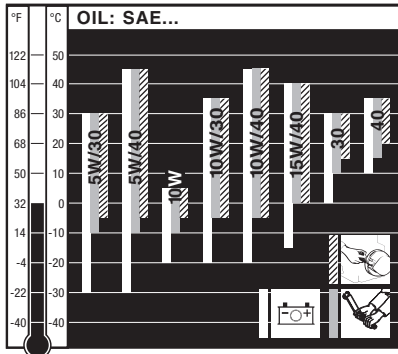

Choose the recommended viscosity based on the type of start (recoil, crank handle or electric) and on the engine temperature at which the engine will be operated.

CAUTION

Engine damage from unsuitable engine oil.

Unsuitable engine oil considerably reduces engine service life. Only use engine oil that fulfills the specifications stipulated above.

4.4 Fuel

Fuel type

All types of diesel fuel that meet the minimum requirements of the following specifications are suitable:

- **Europe: EN 590**
- **UK: BS 2869 A1 / A2**
- **USA: ASTM D 975-09a 1-D S15 or 2-D S15**

CAUTION

Danger of engine damage from low quality fuel.

The use of fuel that does not meet the specifications can lead to engine damage.

- The use of fuels that do not meet specifications require approval by Motorenfabrik HATZ (main plant).

CAUTION**Danger of malfunctions due to old fuel.**

When diesel fuel is stored in a fuel tank or canister for lengthy periods, deposits may form on account of fuel aging. These deposits result in malfunctions due to clogged fuel filters and damage to the injection system.

- Perform the prescribed storage steps in machines that will be out of use for more than three months (see chapter *10.1 Storing the machine, page 94*).
- Only refuel with fresh diesel fuel such as can be obtained from filling stations.

Winter fuel

Diesel fuel loses its fluidity at low temperatures, which can lead to operating problems. Use cold-resistant winter diesel fuel for outside temperatures below 0 °C.

5 Engine overview

5.1 Designation of components

Intake side

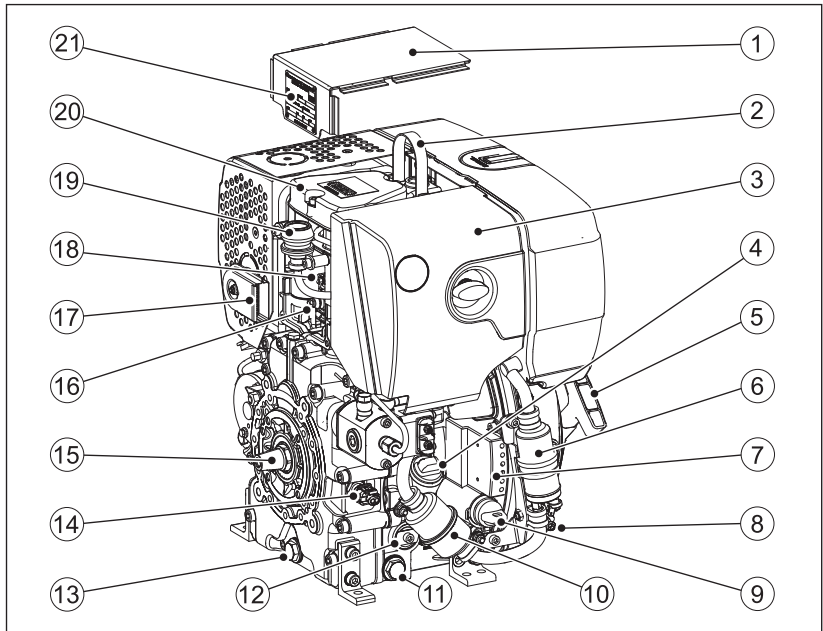

1	Sound protection hood
2	Lifting eye
3	Dry air filter
4	Oil filling opening and dipstick
5	Handle for emergency hand start system (option)
6	Electric fuel pump
7	Indicator lamps
8	Crankshaft speed sensor
9	Ignition lock
10	Main fuel filter
11	Side oil drain screw
12	Screw plug for oil filter
13	Oil drain screw, front

14	Oil temperature sensor
15	Crankshaft – power take-off (pto)
16	Oil pressure switch
17	Exhaust manifold with exhaust screen (exhaust outlet: lateral)
18	Temperature switch
19	Air filter maintenance indicator (option)
20	Cylinder head cover
21	Type plate

Exhaust side (standard model)

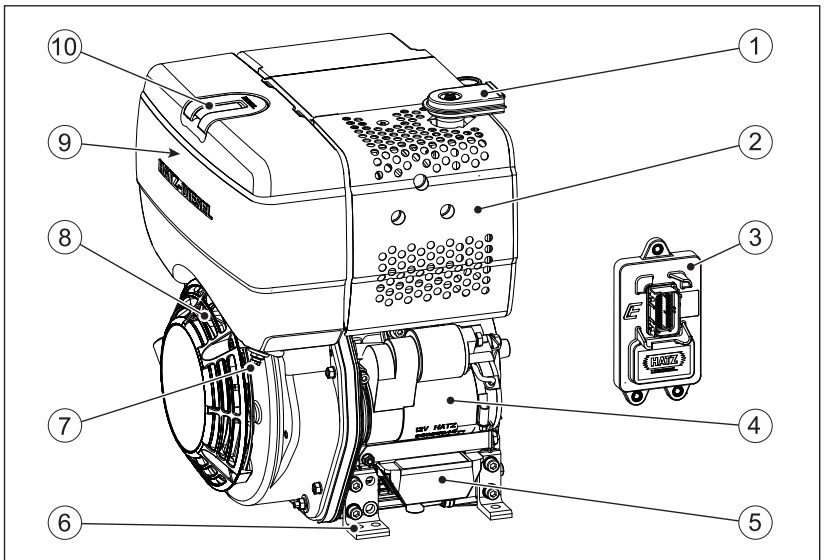

1	Exhaust manifold with exhaust screen (exhaust outlet: top)
2	Silencer with contact protection
3	Engine control unit
4	Starter
5	Voltage controller
6	Engine bracket
7	Water separator
8	Intake opening for cooling and combustion air
9	Fuel prefilter (in tank)

10 Fuel cap

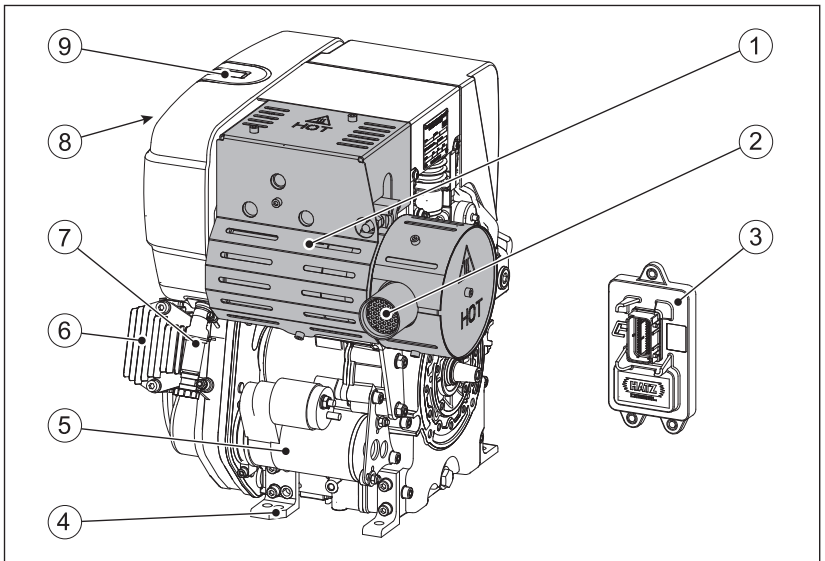
Exhaust side (model with diesel particulate filter)

1	Silencer with diesel particulate filter (DPF) and contact guard
2	Exhaust pipe (exhaust outlet)
3	Engine control unit
4	Engine bracket
5	Starter
6	Voltage controller
7	Water separator with window (option)
8	Fuel prefilter (in tank)
9	Fuel cap

5.2 HATZ instrument box

Overview

Standard (instrument box attached on the engine)

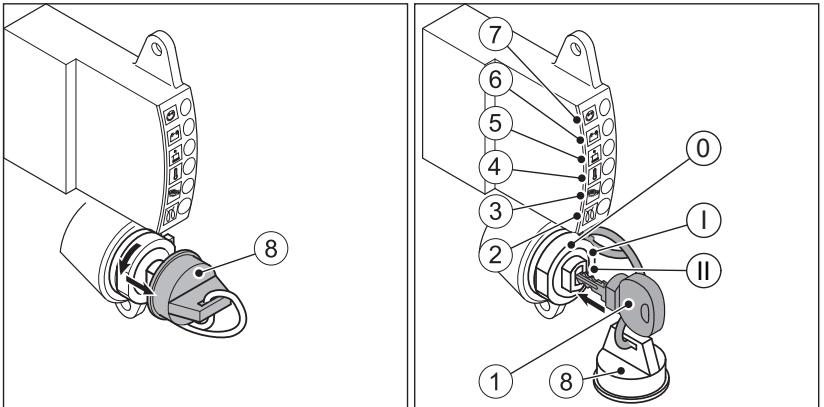



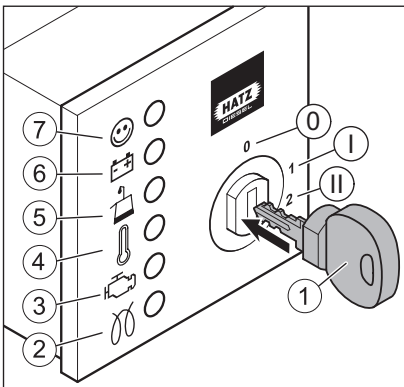

Option (external instrument box)





1	Starting key
2	Pre-glow indicator (option)
3	Engine fault
4	Engine temperature indicator
5	Oil pressure indicator
6	Charge control
7	Operating indicator
8	Protective cap (only for standard instrument box)

Ignition lock	
0	Off
I	Operation
II	Start

Explanation of symbols







Symbol	Meaning
	<p>Operating indicator Lights up during operation when there is no engine fault.</p>
	<p>Charge control Fault in the alternator or alternator charging circuit. The battery is no longer charged. Eliminate the fault immediately.</p>
	<p>Oil pressure indicator Engine oil pressure too low. Danger of engine damage. Stop the engine immediately and check the oil level (see chapter 7.5 <i>Check the oil level, page 46</i>). Contact the HATZ service if the oil level is correct.</p>
	<p>Engine temperature display Engine temperature is impermissibly high. Danger of engine damage. Switch off the engine immediately! For details of troubleshooting, see chapter 9.1 <i>Troubleshooting, page 79</i>.</p>
	<p>Engine fault (symbol with external instrument box) This indicator lights up or flashes if there are engine faults. For details on troubleshooting measures, see 9.2 <i>Flash code table for engine faults, page 83</i>.</p> <p>Depending on the engine specification, the engine controller reacts as follows in case of a malfunction:</p> <ul style="list-style-type: none"> ▪ Emergency operation The engine switches to emergency operation. In this situation, the engine power is reduced or the maximum speed is limited. The engine malfunction indicator lights up. ▪ Engine stop The engine switches off automatically. The engine malfunction indicator flashes. ▪ Warning lamp Only the engine malfunction indicator calls attention to a malfunction.

Symbol	Meaning
	<p>Engine fault (symbol with instrument box built onto engine) This indicator lights up or flashes if there are engine faults. For details on troubleshooting measures, see <i>9.2 Flash code table for engine faults, page 83</i>.</p> <p>Depending on the engine specification, the engine controller reacts as follows in case of a malfunction:</p> <ul style="list-style-type: none">▪ Emergency operation The engine switches to emergency operation. In this situation, the engine power is reduced or the maximum speed is limited. The engine malfunction indicator lights up.▪ Engine stop The engine switches off automatically. The engine malfunction indicator flashes.▪ Warning lamp Only the engine malfunction indicator calls attention to a malfunction.
	<p>Pre-glow indicator Lights at temperatures below 0 °C. Start the engine after the indicator has gone out.</p>

6 Transport, installation and commissioning

6.1 Transport

Safety notes

 WARNING	
	<p>Danger of injury from improper lifting and transport.</p> <p>Danger of crushing from the engine falling or tipping.</p> <ul style="list-style-type: none"> ▪ Only use the lifting eye already mounted on the machine for lifting. ▪ Before lifting the engine, check the lifting eye for damage. Lifting with a damaged lifting eye is not permitted. Replace a damaged lifting eye before using it for lifting. ▪ Only use a suitable hoist with a sufficient carrying capacity. ▪ Do not remain under suspended loads.
 CAUTION	
	<p>Only use the lifting eye for transporting the engine.</p> <p>Do not use for lifting the entire machine.</p>
 CAUTION	
	<p>Danger of injury from overloading the body.</p> <p>Lifting the machine to transport it or to move it to another location can lead to injuries (of the back, for example).</p> <ul style="list-style-type: none"> ▪ Only lift the machine with a hoist.
NOTICE	
	<p>Danger of environmental damage from leaking fluid.</p> <p>If the machine is tilted, engine oil and fuel can run out.</p> <ul style="list-style-type: none"> ▪ Only transport the machine in an upright position.

Transport conditions

- When transporting the machine, follow the safety instructions.
- When transporting, follow the applicable safety and accident prevention regulations.
- After delivery, check the machine for completeness and transport damage.
- Only transport the machine when it is switched off and has cooled down.
- If you have questions on transporting the machine, please contact your nearest **HATZ service station**. For contact data, see chapter 1 *Legal notices*, page 5 or www.hatz-diesel.com.

Access to the lifting eye

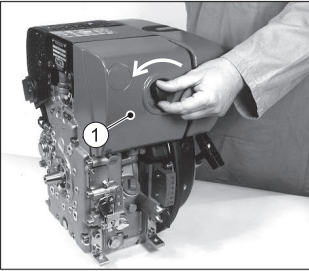
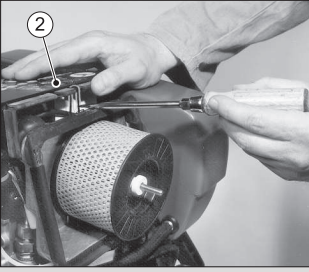
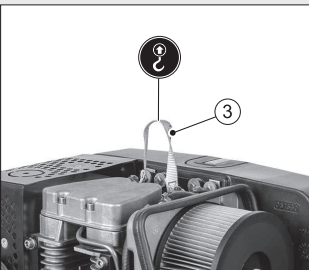
Step	Activity	Figure
1	Unscrew the air filter cover (1).	
2	Remove the sound protection hood (2).	
3	Attach the hoist securely to the lifting eye (3).	

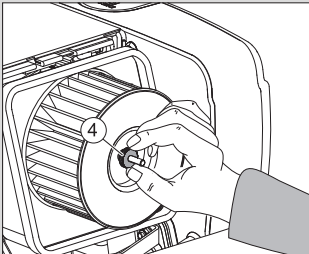
Step	Activity	Figure
4	<p>After completion of transportation, refit the sound protection hood and cover for the air filter.</p> <p><i>Note:</i> Before installing the cover of the air filter, check that the knurled nut (4) is tight.</p>	

6.2 Installation notes

HATZ diesel engines are efficient, robust, and have a long service life. Therefore, they are usually installed in machines that are used for commercial purposes.

The machine manufacturer must follow the applicable regulations regarding machine safety – the engine is a part of a machine.

Depending on the use and installation of the engine, it may be necessary for the machine manufacturer and machine user to install safety equipment to prevent inappropriate use. Note the following:

- Parts of the exhaust gas system and the engine surface become hot during operation and may not be touched until they cool down after the engine is switched off.
- Incorrect cable connections and incorrect operation of the electrical equipment can lead to sparking and must be avoided.
- After the engine is installed in the machine, rotating parts must be protected against contact.
HATZ safety equipment is available for the belt drive of the cooling fan and alternator.
- Comply with all notices and warning labels on the engine and keep them in a legible condition. If an adhesive label should become detached or difficult to read, it must be replaced promptly. For this purpose, contact your nearest **HATZ service station**.
- Any improper modification of the engine will result in a loss of liability coverage for resulting damage.



Only regular maintenance, as specified in this manual, will maintain the operating readiness of the engine.

The **assembly instructions** contain important information on how to safely assemble the engine. They are available from any **Hatz service station**.

If you have any questions, please contact your nearest **HATZ Service** before commissioning the engine.

6.3 Preparations for commissioning



- Check the delivered parts for completeness, damage, and other noticeable issues.
- Ensure that the setup location is adequately ventilated.

 DANGER	
	<p>Danger to life from inhaling exhaust gases.</p> <p>Toxic engine exhaust gases can lead to loss of consciousness, and even death, in closed-off and poorly ventilated rooms.</p> <ul style="list-style-type: none"> ▪ Never operate the machine in closed-off or poorly ventilated rooms. ▪ Do not breathe in the exhaust gases.

6.4 Filling engine oil (first filling)

Engines are normally delivered without an engine oil filling.

Safety notes

 CAUTION	
 	<p>Danger of injury</p> <p>Prolonged contact with engine oil can lead to irritation of the skin.</p> <ul style="list-style-type: none"> ▪ Wear safety gloves. ▪ If there is contact with the skin, thoroughly wash the affected areas of the skin with soap and water.

CAUTION	
	<p>Danger of later engine damage.</p> <ul style="list-style-type: none"> ▪ Operating the engine with an oil level below the min. mark or above the max. mark can lead to engine damage. ▪ When checking the oil level, the engine must be horizontal and have been switched off for a few minutes.

Overview

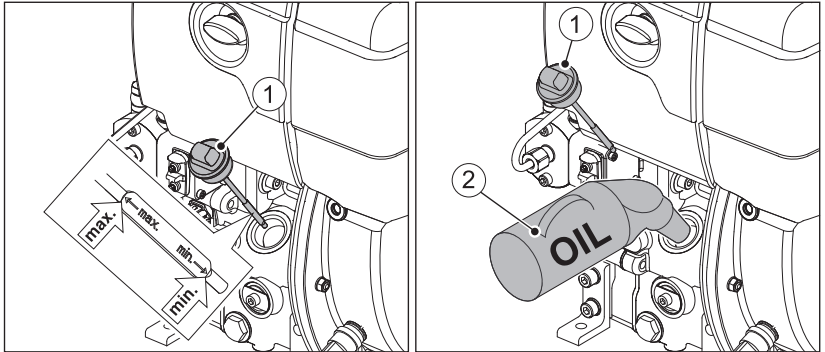

1	Dipstick
2	Oil refilling container

Procedure

Step	Activity
1	Unscrew the dipstick (1) and wipe it off with a clean towel.
2	Fill engine oil. For the specification and viscosity, see chapter 4.3 <i>Engine oil</i> , page 24. See chapter 4.1 <i>Engine information and filling quantities</i> , page 21 for the engine oil capacity.
3	Reinsert the dipstick and screw it tight.
4	Unscrew the dipstick and check the oil level.
5	If necessary, add engine oil to the max. mark.
6	Reinsert the dipstick and screw it tight.

6.5 Venting the fuel system

Requirements

The fuel system must be bled in the following situations:

- At first filling of the fuel tank
- After changing the fuel filter
- Engine shuts down due to empty fuel tank

Overview

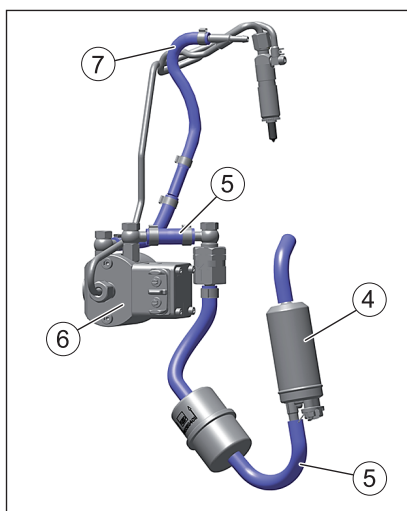
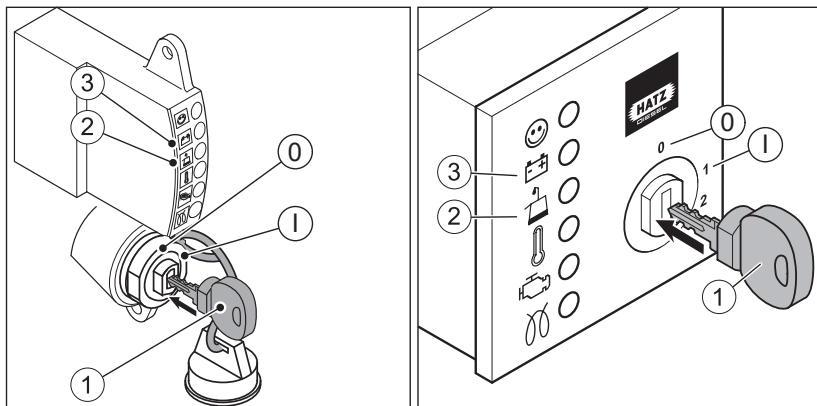

1	Starting key
2	Oil pressure indicator
3	Charge control
Ignition lock	
0	Off
I	Operation
Fuel system	
4	Fuel pump
5	Fuel supply line to injection pump

6	Injection pump
7	Fuel return line to tank

Procedure

Step	Activity
1	<p>Insert the starting key all the way and turn to position "I".</p> <p>The oil pressure indicator (2) and charge control (3) light up.</p>
2	<p>Leave the starting key at position "I" until the electrical fuel feed pump (4) switches off after approx. 10 seconds.</p>
3	<p>Turn the starting key back to position "0".</p> <p><i>Note:</i> Perform steps 2 and 3 several times to remove air bubbles from the fuel supply line (5) and the injection pump (6). The air escapes via the fuel return line (7) in the tank.</p>
4	<p>Start the engine, see chap. 7.3 <i>Starting the engine</i>, page 41.</p> <p>If the engine is difficult to start, proceed as follows:</p> <ul style="list-style-type: none"> ▪ Hold the starting key in position "II" continuously without interruption until the engine starts, but not longer than 30 seconds. <p>If the engine does not start on the first attempt, the starting procedure can be repeated after waiting at least 30 seconds. After three unsuccessful start attempts, turn the starting key to the "0" position and determine the cause of the fault; see chap. 9.1 <i>Troubleshooting</i>, page 79.</p>

7 Operation and use

7.1 Safety notes

NOTICE



Comply with the safety chapter!

Follow the basic safety instructions in chapter 3 *Safety*, page 7.



WARNING



Danger of injury from damage and defects on the machine.

- Do not take the machine into service if damage has been localized and identified.
- Replace defective components.



WARNING



Danger of injury from failure to follow the operating instructions and from performing unauthorized tasks on the machine.

- Define the responsibilities of the personnel taking the machine into service.
- Replace defective machine parts immediately.
- Check the installation conditions when the machine is first taken into service and after the machine has been inactive for a lengthy period.

CAUTION

Danger of engine damage from low load operation.

Operating the engine at no load or at very low load for an extended period can impair the running characteristics of the engine.

- Make sure that the engine load is at least 15 %.
- Before switching off the engine following low load operation, briefly operate it at a considerably higher load.

7.2 Performing tests

Before starting

Before starting the engine, several tests need to be performed to ensure the machine is working properly.



Procedure

Step	Test
1	The machine is standing securely and on a level surface.
2	The installation location is adequately ventilated.
3	There is a sufficient amount of fuel in the fuel tank (see chapter 7.6 <i>Refueling</i> , page 48).
4	There is a sufficient amount of engine oil in the engine housing (see chapter 6.4 <i>Filling engine oil (first filling)</i> , page 36).
5	No persons are located in the danger zone of the engine or machine.
6	All safety equipment is in place.

7.3 Starting the engine

If possible, separate the engine from the machine being driven by uncoupling it. Always switch the machine into idle mode.

Safety notes

 DANGER	
	<p>Danger to life from inhaling exhaust gases.</p> <p>Toxic engine exhaust gases can lead to loss of consciousness, and even death, in closed-off and poorly ventilated rooms.</p> <ul style="list-style-type: none"> ▪ Never operate the machine in closed-off or poorly ventilated rooms. ▪ Do not breathe in the exhaust gases.
CAUTION	
	<p>Danger of engine damage from the use of starting fluid.</p> <ul style="list-style-type: none"> ▪ Engine damage from the use of starting fluid can lead to uncontrolled ignition. ▪ Engine damage from uncontrolled ignition. ▪ Never use starting fluid.

NOTICE



See also starting instructions in the documentation for the complete machine.

Overview – HATZ instrument boxes

Standard (instrument box attached on the engine)

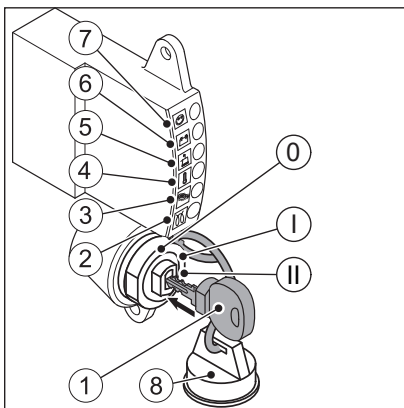
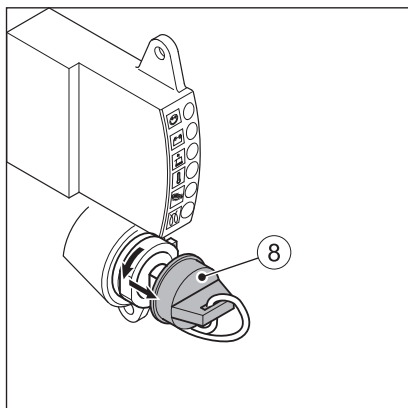

Option (external instrument box)

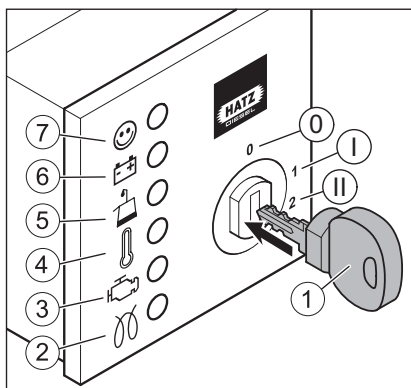

1	Starting key
2	Pre-glow indicator (option)
3	Engine fault
4	Engine temperature indicator
5	Oil pressure indicator

6	Charge control
7	Operating indicator
8	Protective cap (only for standard instrument box)
Ignition lock	
0	Off
I	Operation
II	Start

NOTICE

For further details on the instrument box, see chapter 5.2 *HATZ instrument box*, page 30.

Procedure**NOTICE**

- Start for max. 30 seconds. If the engine still does not start, the starting procedure can be repeated after waiting at least 30 seconds. After three unsuccessful start attempts, find the cause of the fault (see chap. 9.1 *Troubleshooting*, page 79).
- Turn the starting key to position "0" every time you want to start the engine.
- The anti repeat device in the ignition lock makes it impossible for the starter to engage while the engine is running and become damaged.

Step	Activity
1	Remove the protective cap (8) from the ignition lock (only for standard instrument box).
2	Insert the starting key all the way and turn to position "I". The oil pressure indicator (5) and charge control (6) light up. When the pre-glow indicator (2) lights up, wait until it goes out and then continue with the next step.
3	Turn the starting key to position "II".

Step	Activity
4	<p>As soon as the engine is running, release the starting key.</p> <ul style="list-style-type: none"> ▪ The starting key springs back to position "I" and remains in this position during operation. ▪ The oil pressure indicator (5) and charge control (6) must go out. ▪ The operating indicator (7) lights up and signals that there is no engine fault.

NOTICE



- In case of irregularities, switch off the engine immediately.
- Identify the fault and eliminate it.
- For details of troubleshooting, see chapter 9.1 *Troubleshooting*, page 79.

7.4 Switching off the engine

Safety notes



CAUTION



Danger of injury from unauthorized access.

There is a danger of injury if unauthorized persons handle the machine.

- Protect the starting key against unauthorized access during breaks in operation or after completing work.

CAUTION

Protect the ignition lock against dirt and moisture.

- With the starting key pulled out, seal the ignition lock with the protective cap.

Overview – HATZ instrument boxes

Standard

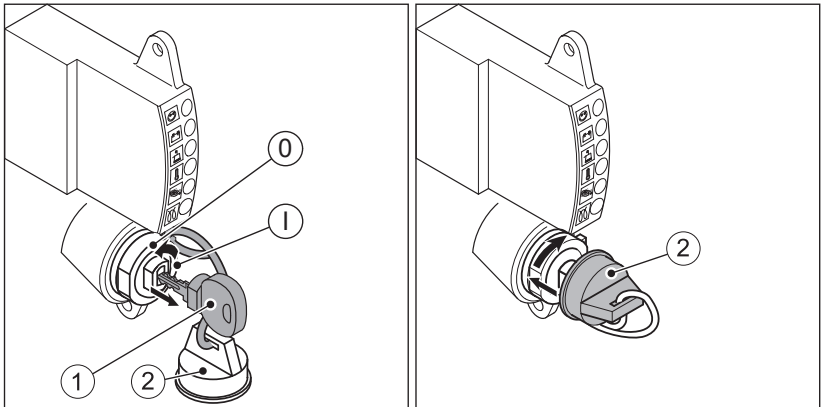

Option

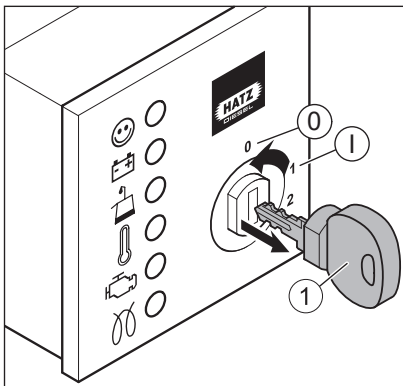

1	Starting key
2	Protective cap (only for standard instrument box)
Ignition lock	
0	Off
1	Operation

Procedure

Step	Activity
1	Turn the starting key to position "0". The engine switches off. All indicator lamps go out. <i>Note:</i> The engine continues running for several seconds after it is switched off. Before performing any further activities, wait until all moving components have come to a complete standstill.
2	Remove the starting key.
3	Close the ignition lock with the protective cap (only for standard instrument box).

NOTICE



Danger of exhaustive battery discharge.

- When the machine is switched off, always turn the starting key to position "0" or else the battery may become fully discharged.

7.5 Check the oil level

Safety notes



CAUTION



Danger of burns.

- There is a danger of burns when working on a hot engine.
- Wear safety gloves.



CAUTION



Danger of injury

Prolonged contact with engine oil can lead to irritation of the skin.

- Wear safety gloves.
- If there is contact with the skin, thoroughly wash the affected areas of the skin with soap and water.



CAUTION**Danger of later engine damage.**

- Operating the engine with an oil level below the **min.** mark or above the **max.** mark can lead to engine damage.
- When checking the oil level, the engine must be horizontal and have been switched off for a few minutes.

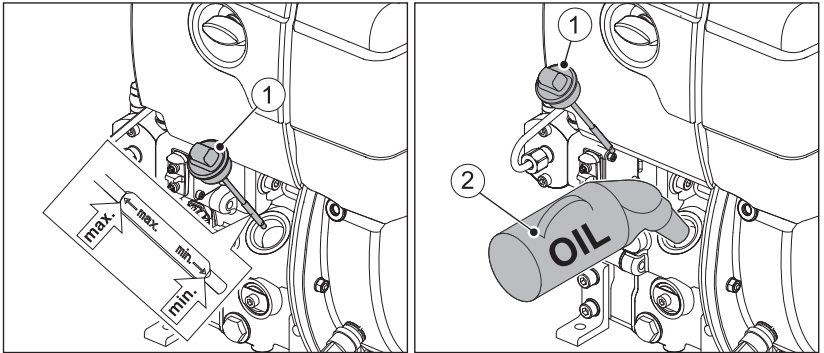
Overview









1	Dipstick
2	Oil refilling container

Procedure

Step	Activity
1	Switch off the engine and wait several minutes for the engine oil to collect in the crankcase. The engine must be level.
2	Remove contamination on the engine in the area of the dipstick.
3	Unscrew the dipstick and wipe it off with a clean towel.
4	Reinsert the dipstick and screw it tight.
5	Unscrew the dipstick and check the oil level.
6	If the oil level is close to the min. mark, add engine oil to the max. mark.
7	Reinsert the dipstick and screw it tight.

7.6 Refueling

Safety notes

 DANGER	
 	<p>Fire hazard from fuel.</p> <p>Leaked or spilled fuel can ignite on hot engine parts and cause serious burn injuries.</p> <ul style="list-style-type: none"> ▪ Only refuel when the engine is switched off and has cooled down. ▪ Never refuel in the vicinity of open flames or sparks that can cause ignition. ▪ Do not smoke. ▪ Do not spill fuel.
 CAUTION	
	<p>Danger of environmental damage from spilled fuel.</p> <p>Do not overfill the fuel tank and do not spill fuel.</p> <ul style="list-style-type: none"> ▪ Collect any leaking fuel and dispose of it according to local environmental regulations.
 CAUTION	
 	<p>Danger of injury.</p> <p>Repeated contact with diesel fuel can cause chapped and cracked skin.</p> <ul style="list-style-type: none"> ▪ Wear safety gloves. ▪ If there is contact with the skin, thoroughly wash the affected areas of the skin with soap and water.
CAUTION	
	<p>Engine damage from using low quality fuel.</p> <p>The use of fuel that does not meet the specifications can lead to engine damage.</p> <ul style="list-style-type: none"> ▪ Only use the fuel specified in chapter 4.4 <i>Fuel</i>, page 25. ▪ The use of fuels that do not meet specifications require approval by Motorenfabrik HATZ (main plant).

Overview

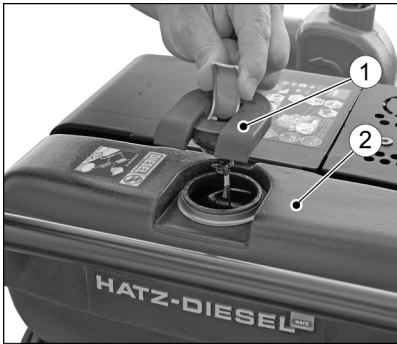

1	Fuel cap
2	Fuel tank

Procedure



Step	Activity	Figure
1	Open the fuel cap.	
2	Fill the fuel tank with diesel fuel.	

Step	Activity	Figure
3	Close the fuel cap.	

NOTICE	
	<p>Never run the tank empty if possible, as otherwise air can enter the fuel system. This can lead to damage to the injection system.</p> <p>If the tank is still run empty, proceed as follows:</p> <ul style="list-style-type: none"> ▪ Fill the fuel tank with diesel fuel. ▪ Bleed the fuel system (see chapter 6.5 <i>Venting the fuel system</i>, page 37).

7.7 Checking the water separator

Safety notes

 CAUTION	
	<p>Danger of environmental damage from spilled fuel.</p> <p>When water is drained from the water separator, a small amount of fuel is drained as well.</p> <ul style="list-style-type: none"> ▪ Collect any escaped water/fuel mixture and dispose of it according to local environmental regulations.

NOTICE	
	<p>The interval for checking the water separator depends entirely on the proportion of water in the fuel and on the care exercised during refueling; the water separator should be checked at least once a week.</p>

Overview

Water in the fuel tank collects at the lowest point of the fuel tank in the water separator.

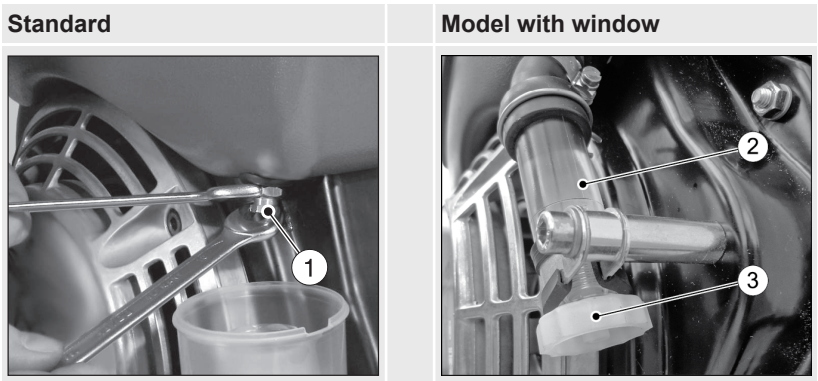

1	Drain screw, hex (standard)
2	Window (additional equipment)
3	Drain screw (manually operated)

Procedure

Step	Activity
1	Model with window: Check the window (2) for water content. Collected water can be clearly identified by the noticeable separating line between the water and the diesel fuel above it.
2	Place a suitable container under the drain screw (1) or (3). <i>NOTE:</i> In inaccessible locations, an extension hose can be mounted on the drain screw (3).
3	Open the drain screw (1) or (3) and drain the water into the container.
4	When fuel emerges, close the drain screw.
5	Dispose of the water/fuel mixture in accordance with the local environmental regulations.

7.8 Check the air filter warning indicator (option)

Overview

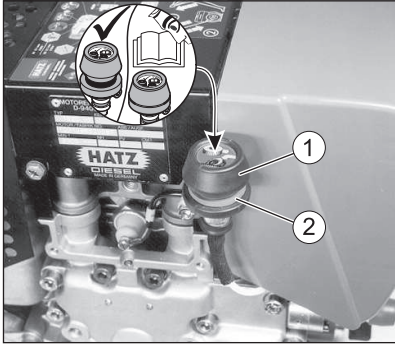

1	Rubber bellow
2	Green field



Procedure

Step	Activity
1	Bring the engine briefly to maximum speed.
2	When the rubber bellow (1) contracts and covers over the green field (2), immediately check the air filter system (see chapter 8.2.11 <i>Maintaining the dry air filter</i> , page 75).
3	Check the rubber bellow (1) several times daily under dusty conditions.

8 Maintenance

8.1 General maintenance instructions

Safety notes

 WARNING	
	<p>Danger of injury from failure to follow the Operating Instructions and from performing unauthorized tasks on the machine.</p> <ul style="list-style-type: none"> ▪ Follow all instructions. ▪ Do not perform activities for which no qualification is available. Contact properly trained personnel if necessary.

NOTICE	
	<p>Comply with the safety chapter!</p> <p>Follow the basic safety instructions in chapter 3 <i>Safety</i>, page 7.</p>

- Maintenance tasks may only be performed by trained personnel.
- Accident prevention measures must be in accordance with the local accident prevention regulations.
- Perform setting and maintenance work at the specified intervals.
- Replace defective machine parts as soon as possible.
- Always wear personal protection equipment.
- Only use fully functional tools.
- Installation of unsuitable spare parts can lead to problems. We cannot accept liability for direct damage or secondary damage that results from this. We therefore recommend the use of **Hatz original spare parts**.
- Closely adhere to the maintenance conditions prescribed in this manual.
- Only make changes to the machine in agreement with the manufacturer.
- Only perform maintenance work when the engine is switched off.
- Protect the starting key from unauthorized access.
- Disconnect the negative battery terminal before carrying out maintenance work.
- Adhere to legal regulations when handling and disposing of used oil, filters, and cleaning agents.
- After completing maintenance work, check that all tools, screws, aids, and other objects are removed from the machine, and that all safety equipment has been replaced.

- Before starting, ensure that no persons are located in the danger zone of the engine or machine.



Performance of maintenance work

The entire machine is designed to be maintenance friendly. Parts that require maintenance are easily accessible.

- Perform maintenance work faithfully at the specified intervals to prevent premature wear of the machine.
- Follow the notice and warning labels on the machine.
- Always retighten screw connections loosened during maintenance work.
- After the necessary maintenance and repair work is completed, perform a function test (test run).
- For maintenance work that is not listed and described in the maintenance documentation, please contact your nearest **HATZ service station**.

8.2 Maintenance work

Safety note

 CAUTION	
	<p>Danger of injury from ignoring the maintenance instructions.</p> <ul style="list-style-type: none"> ▪ Only perform maintenance work when the engine is switched off. ▪ Protect the starting key from unauthorized access. ▪ Disconnect the negative battery terminal. ▪ When the maintenance work has been completed, ensure that all tools are removed from the machine.

8.2.1 Maintenance notice label

NOTICE	
	<p>The following illustrated maintenance label is delivered with every engine.</p> <ul style="list-style-type: none"> ▪ It should be mounted on the engine or machine in a clearly visible location. ▪ The maintenance intervals specified on the maintenance plan must be adhered to (see chapter 8.2.2 <i>Maintenance plan, page 55</i>)

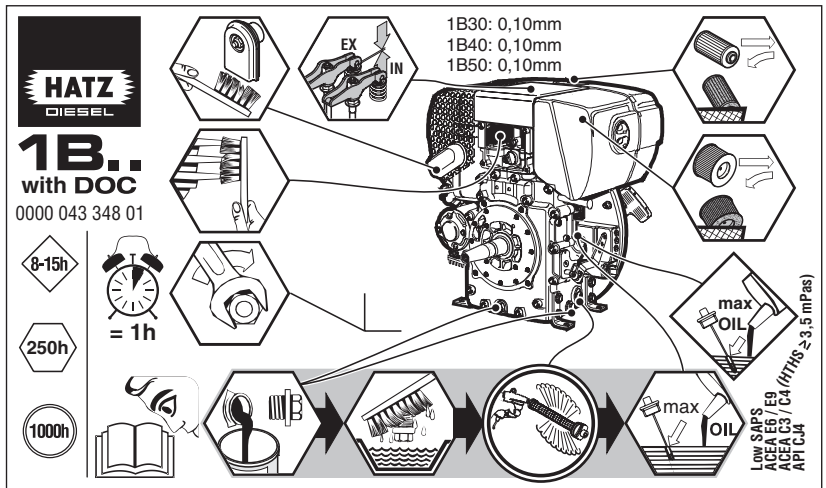

8.2.2 Maintenance plan

NOTICE



The maintenance intervals listed below apply to standard applications. If the operating conditions differ significantly from the usual use cases, it is possible that Hatz and the manufacturer of the complete machine reached a special agreement stipulating shorter or longer maintenance intervals. Corresponding information regarding different maintenance intervals can be found in the documentation of the complete machine.



Daily checks

Symbol	Interval	Activity/check	Chapter
	Every 8–15 operating hours or every day before starting	Check the oil level	7.5 <i>Check the oil level, page 46</i>
		Check the intake area of the combustion air and cooling air	8.2.3 <i>Checking the intake area, page 57</i>
		Check the air filter maintenance indicator	7.8 <i>Check the air filter warning indicator (option), page 52</i>

Initial service of new or rebuilt engines

Symbol	Service interval	Service step/check	Section
	After the first 25 operating hours	Change the engine oil ²⁾	<i>8.2.4 Change the engine oil, page 58</i>
		Check and set the tappet clearance	<i>8.2.6 Checking and setting the tappet clearance, page 64</i>
		Check the screw connections	<i>8.2.8 Check the screw connections, page 70</i>

Routine service

Symbol	Service interval	Service step/check	Section
	Weekly	Check the water separator	<i>7.7 Checking the water separator, page 50</i>
	Every 250 operating hours or every 12 months	Diagnosis of engine management ¹⁾²⁾ (to be performed by trained technicians)	
		Update of the engine control unit ²⁾³⁾ (to be performed by trained personnel)	
		Change the engine oil ²⁾	<i>8.2.4 Change the engine oil, page 58</i>
		Check and adjust the tappet clearance ²⁾	<i>8.2.6 Checking and setting the tappet clearance, page 64</i>
		Clean the cooling air area ²⁾	<i>8.2.7 Cleaning the cooling air area, page 67</i>
		Check the screw connections ²⁾	<i>8.2.8 Check the screw connections, page 70</i>
		Clean the exhaust screen ²⁾	<i>8.2.9 Clean the exhaust screen, page 70</i>
		Change the fuel prefilter and main fuel filter ²⁾⁴⁾	<i>8.2.10 Changing the fuel filter, page 72</i>
		Maintain the dry air filter ²⁾	<i>8.2.11 Maintaining the dry air filter, page 75</i>
	Every 500 operating hours	Clean the diesel particulate filter (DPF) ⁶⁾ (to be performed by trained technicians)	

Symbol	Service interval	Service step/check	Section
	Every 1000 operating hours or every 4 years	Clean the oil filter ⁵⁾	8.2.5 <i>Clean the oil filter, page 61</i>
	Every 1500 operating hours	Change the diesel particulate filter (DPF)	

¹⁾ The engine control module continuously evaluates the engine-relevant data during operation. If an engine malfunction or deviations from the setpoints occur, these data are written to the error memory. Stored data can be read out and evaluated for fault diagnostics by a Hatz service partner using the Hatz Diagnostic Software HDS². In this way, faults can be detected and eliminated early on or preventative maintenance can be performed.

²⁾ Service according to the service interval or after 12 months, whichever comes first.

³⁾ The engine control unit can only be updated using the Hatz diagnostic software HDS². The update installs extensions and improvements of the control software.

⁴⁾ The interval at which maintenance work should be performed on the fuel filter depends on the cleanliness of the fuel in use and may need to be shortened to 150 operating hours.



⁵⁾ Maintenance according to the maintenance interval or after 4 years, whichever comes first

⁶⁾ Only for model with diesel particulate filter, see chap. 5 *Engine overview, page 27*. Hatz offers the **EasyClean** cleaning program for overhauling the diesel particulate filter.

For more information, see <https://parts.hatz.com/service/easyclean/>

8.2.3 Checking the intake area

Safety notes

 CAUTION	
 	<p>Danger of burns.</p> <p>There is a danger of burns when working on a hot engine.</p> <ul style="list-style-type: none"> ▪ Let the engine cool. ▪ Wear safety gloves.

NOTICE

In case of heavy contamination, shorten the maintenance intervals accordingly (see chapter 8.2.2 *Maintenance plan, page 55*).

Overview

Standard	Model with cyclone precleaner
1	Air intake opening
2	Intake area of cyclone precleaner
3	Dust outlet opening

Procedure









Step	Activity
1	<p>Check the air intake opening (1) for coarse contamination such as leaves, heavy dust deposits, etc.</p> <p>Perform the following activities in case of heavy contamination:</p> <ul style="list-style-type: none"> ▪ Chap. 8.2.7 <i>Cleaning the cooling air area, page 67.</i> ▪ Chap. 8.2.11 <i>Maintaining the dry air filter, page 75.</i>
2	<p>In models with a cyclone precleaner, also check and if necessary clean the intake area (2) in addition to step 1.</p> <p>Check that the dust outlet opening (3) is clear and clean it if necessary.</p>

8.2.4 Change the engine oil

This chapter contains the following subchapters:

- **Draining the engine oil**
- **Filling the engine oil**

Safety notes

 CAUTION	
 	<p>Danger of burns.</p> <p>When working on the engine, there is a danger of burns from hot oil.</p> <ul style="list-style-type: none"> ▪ Wear personal protective equipment (gloves).
 CAUTION	
	<p>Danger of environmental damage from spilled used oil.</p> <p>Used oil is water-polluting.</p> <ul style="list-style-type: none"> ▪ Do not allow them to enter the ground water, water bodies, or sewage system. ▪ Collect the used oil and dispose of it according to local environmental regulations.
 CAUTION	
 	<p>Danger of injury</p> <p>Prolonged contact with engine oil can lead to irritation of the skin.</p> <ul style="list-style-type: none"> ▪ Wear safety gloves. ▪ If there is contact with the skin, thoroughly wash the affected areas of the skin with soap and water.
CAUTION	
	<p>Danger of later engine damage.</p> <ul style="list-style-type: none"> ▪ Operating the engine with an oil level below the min. mark or above the max. mark can lead to engine damage. ▪ When checking the oil level, the engine must be horizontal and have been switched off for a few minutes.
NOTICE	
	<ul style="list-style-type: none"> ▪ The engine must be level. ▪ The engine must be switched off. ▪ Only drain engine oil while it is warm.

Draining the engine oil

Overview

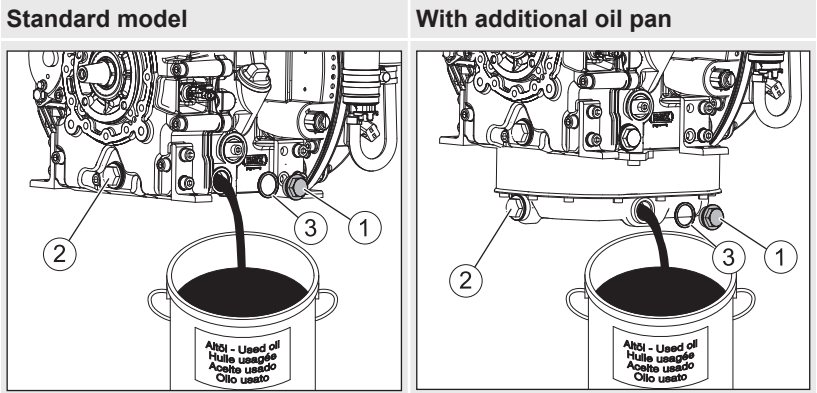

1	Oil drain screw (side)
2	Oil drain screw (front)
3	Seal ring

Procedure

Step	Activity
1	Keep a container ready for collecting the used oil. The container must be large enough to hold the entire amount of engine oil. For the engine oil capacity, see chapter 4.1 <i>Engine information and filling quantities</i> , page 21.
2	Depending on accessibility, the engine oil can be drained at oil drain screw (1) or (2). Unscrew the oil drain screw and drain the used oil entirely.
3	Screw in the cleaned oil drain screw with the new sealing ring and tighten. Tightening torque: 50 Nm.

Filling the engine oil

Overview

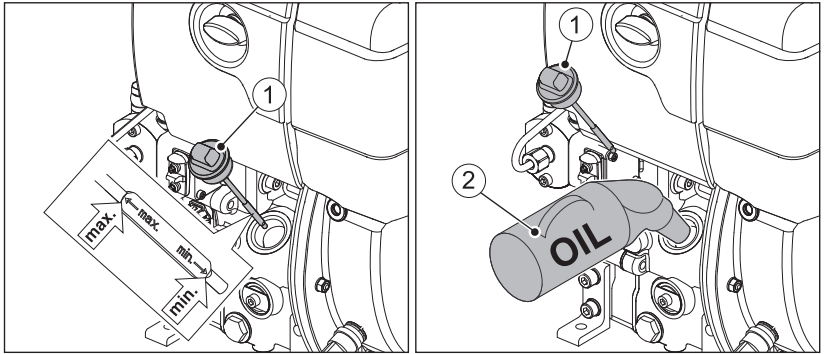



1	Dipstick
2	Oil refilling container

Procedure

Step	Activity
1	Unscrew the dipstick (1) and wipe it off with a clean towel.
2	Fill engine oil. For the specification and viscosity, see chapter 4.3 <i>Engine oil</i> , page 24. See chapter 4.1 <i>Engine information and filling quantities</i> , page 21 for the engine oil capacity.
3	Reinsert the dipstick and screw it tight.
4	Unscrew the dipstick and check the oil level.
5	If necessary, add engine oil to the max. mark.
6	Reinsert the dipstick and screw it tight.

8.2.5 Clean the oil filter

Safety notes

 CAUTION	
	<p>Danger of burns.</p> <p>There is a danger of burns when working on a hot engine.</p> <ul style="list-style-type: none"> Let the engine cool before maintenance.

**CAUTION****Danger of injury**

Prolonged contact with engine oil can lead to irritation of the skin.



- Wear safety gloves.
- If there is contact with the skin, thoroughly wash the affected areas of the skin with soap and water.

**CAUTION****Danger of injury.**

When working with compressed air, foreign bodies may fly into your eyes.



- Wear safety goggles.
- Never direct the compressed air jet toward people or toward yourself.

NOTICE



- Collect the emerging oil and dispose of it according to local environmental regulations.

NOTICE

- The oil filter should be cleaned when the engine oil is changed (see chapter 8.2.4 *Change the engine oil*, page 58), since oil will run out when the filter is pulled out.

Procedure

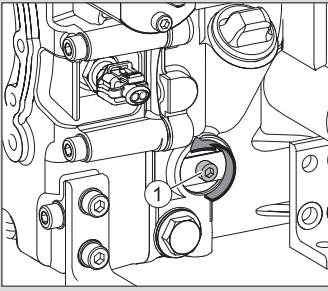
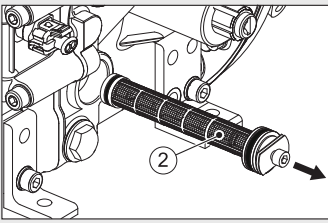
Step	Activity	Figure
1	Keep a container ready for collecting the used oil.	

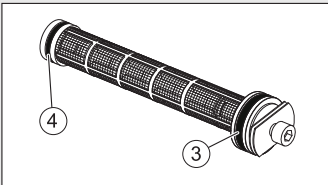
Step	Activity	Figure
2	Loosen the screw (1) by approx. five turns.	
3	Pull the oil filter (2) out of the housing.	
4	Blow out the oil filter from the inside to the outside with compressed air.	
5	Check the sealing rings (3+4) for damage and renew if necessary.	
6	Lightly oil the sealing rings before installation.	

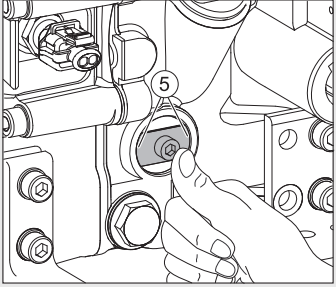
Step	Activity	Figure
7	Insert the oil filter and press it all the way in.	
8	Before tightening the screw, ensure that the tension springs (5) rest against the oil filter at both ends. Tighten the screw.	
9	Check the oil level and add oil to the max. mark if necessary (see chapter 7.5 <i>Check the oil level</i> , page 46).	

8.2.6 Checking and setting the tappet clearance

Safety notes



CAUTION



Danger of burns.

There is a danger of burns when working on a hot engine. Only perform the settings while the engine is cold (10-30 °C).

- Let the engine cool.



CAUTION



Damage from inadequate engine cooling.

Only operate the engine when all covers are installed.

Preparation

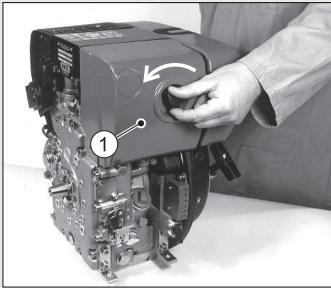
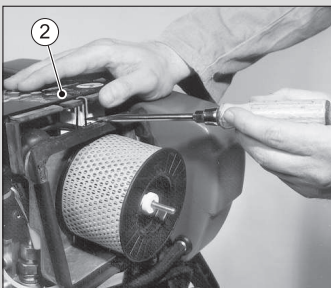
Step	Activity	Figure
1	Unscrew the air filter cover (1).	
2	Remove the sound protection hood (2).	

Procedure

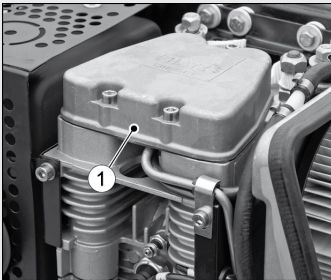

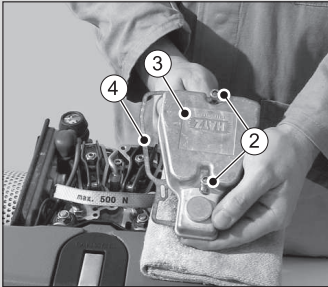
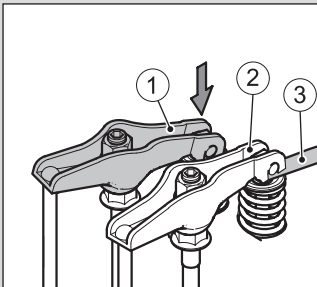
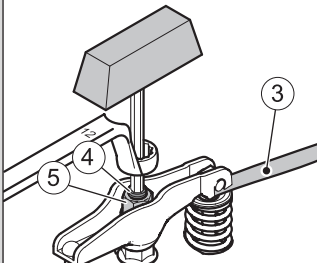

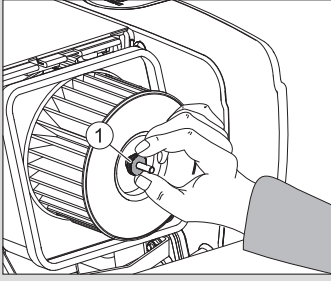
Step	Activity	Figure
1	Remove dirt in the area of the cylinder head cover (1).	

Step	Activity	Figure
2	Remove the screws (2). 2 screws in 1B30E, 3 screws in 1B50E.	
3	Take off the cover (3) with the gasket (4).	
4	Turn the engine in the sense of rotation until the rocker arm (1) has fully opened the outlet valve. Then check the tappet clearance at the rocker arm (2) with a feeler gauge (3). For the setting, see chapter 4.1 <i>Engine information and filling quantities</i> , page 21.	
5	Turn the engine in the sense of rotation until the rocker arm (2) has fully opened the inlet valve. Now check the tappet clearance at the rocker arm (1).	
6	If the tappet clearance needs to be corrected: Release the screw (4) and turn the hexagon nut (5) so the feeler gauge (3) can be pulled through with a barely perceptible resistance after the screw (4) is tightened again.	
7	Mount the cylinder head cover with the new gasket and tighten evenly.	



Step	Activity	Figure
8	Fully assemble the engine. <i>Note:</i> Before installing the cover of the air filter, check that the knurled nut (1) is tight.	
9	Perform a test run. Check the cylinder head cover for tightness.	

8.2.7 Cleaning the cooling air area

Safety notes

 CAUTION	
	Danger of burns. There is a danger of burns when working on a hot engine. <ul style="list-style-type: none"> ▪ Let the engine cool before maintenance.
 CAUTION	
 	Danger of injury. When working with compressed air, foreign bodies may fly into your eyes. <ul style="list-style-type: none"> ▪ Wear safety goggles. ▪ Never direct the compressed air jet toward people or toward yourself.
CAUTION	
	Danger of damage to the machine from incorrect engine cleaning. <ul style="list-style-type: none"> ▪ Let the engine fully cool down before cleaning. ▪ Do not spray components of the electrical equipment with a water jet or high pressure jet during cleaning.

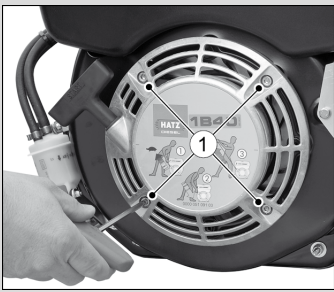
Procedure

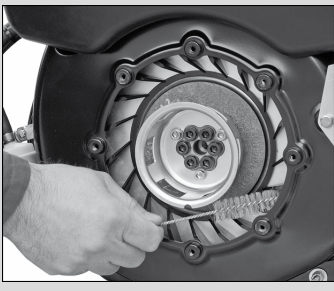
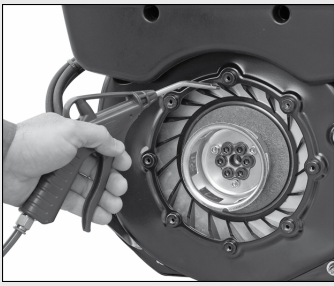
Step	Activity	Figure
Dry contamination		
1	Remove the screws (1).	
2	Take off the recoil start (2) and clean it.	
3	Clean the fan blades with a suitable brush.	
4	Then blow it out with compressed air.	

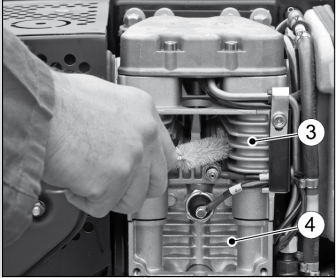
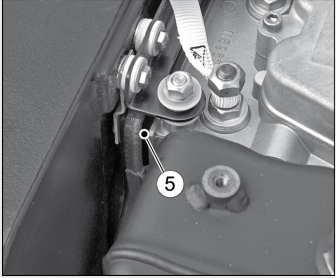
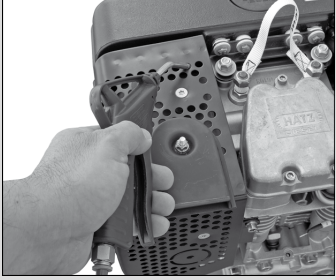
Step	Activity	Figure
5	Also clean the cooling ribs of the cylinder head (3) and cylinder (4) and blow out with compressed air.	
6	Check the air gap (5) for dirt and clean with compressed air if necessary.	
7	The element can be checked and cleaned through the holes in the contact guard.	
8	Mount the recoil start (2) again.	
Moist or oily contamination		
1	Contact HATZ service.	

8.2.8 Check the screw connections

Safety note





NOTICE	
	<ul style="list-style-type: none"> ▪ Do not retighten the screws for attaching the cylinder head. ▪ Only retighten loose screw connections. Screw connections can be secured with thread locking adhesive or tightened to a defined torque. Retightening tight screw connections can cause damage.

Procedure

Step	Activity
1	Check the condition of all screw connections and ensure that they are tight (for exceptions, see note).
2	Tighten any loose screw connections.

8.2.9 Clean the exhaust screen

Safety notes

 CAUTION	
	<p>Danger of burns.</p> <p>There is a danger of burns when working on a hot engine.</p> <ul style="list-style-type: none"> ▪ Let the engine cool before maintenance.
 CAUTION	
 	<p>Danger of injury</p> <p>There is a danger of injury when performing cleaning work at the exhaust screen.</p> <ul style="list-style-type: none"> ▪ Wear safety gloves.

Procedure

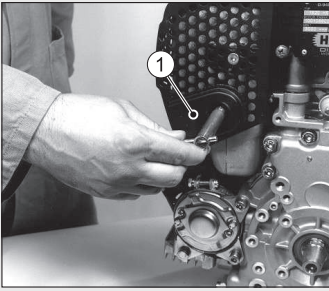
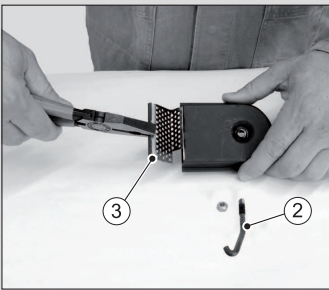
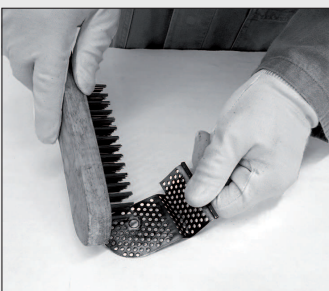
Step	Activity	Figure
1	Release the hex nut and take off the exhaust manifold (1).	
2	Remove the hex nut from the bracket (2) and pull out the screen insert (3).	
3	Remove the deposits in the screen insert with a suitable wire brush.	
4	Check the screen insert for cracks or breakage, and replace if necessary.	
5	Mount the screen insert and bracket again.	

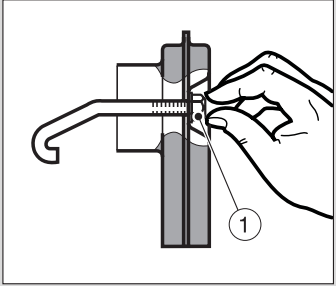
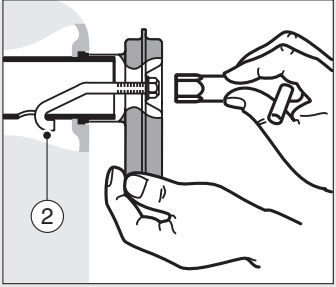

Step	Activity	Figure
6	Tighten the hex nut (1) by approx. one turn.	
7	Insert the exhaust manifold with the bracket (2) into the hole and pull it back to the outside so that the bracket can no longer become unhooked.	
8	Tighten the hex nut.	





8.2.10 Changing the fuel filter

This chapter contains the following subchapters:

- **Changing the fuel prefilter**
- **Changing the main fuel filter**

Safety notes

 DANGER	
 	<p>Fire hazard from fuel</p> <p>Leaked or spilled fuel can ignite on hot engine parts and cause serious burn injuries.</p> <ul style="list-style-type: none"> ▪ Do not spill fuel. ▪ No open flames when working on the fuel system. ▪ Do not smoke.

 CAUTION	
 	<p>Danger of injury.</p> <p>Repeated contact with diesel fuel can cause chapped and cracked skin.</p> <ul style="list-style-type: none"> ▪ Wear safety gloves. ▪ If there is contact with the skin, thoroughly wash the affected areas of the skin with soap and water.
 CAUTION	
	<p>Danger of environmental damage from spilled fuel.</p> <p>When the filter is removed, a small amount of fuel is drained as well.</p> <ul style="list-style-type: none"> ▪ Collect any escaping fuel and dispose of it according to local environmental regulations.
CAUTION	
	<p>Dirt particles can damage the injection system.</p> <ul style="list-style-type: none"> ▪ Maintain clean conditions to ensure dirt does not enter the fuel line.

Changing the fuel prefilter

Procedure

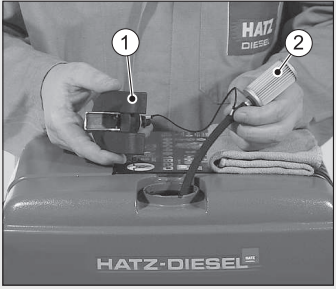
Step	Activity	Figure
1	Open the fuel cap (1) and pull the fuel prefilter (2) out of the tank by the cord.	

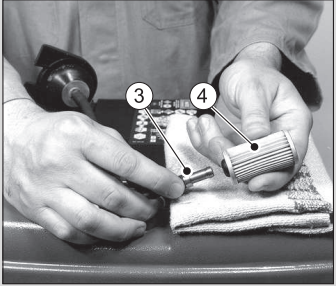
Step	Activity	Figure
2	Pull the fuel feed line (3) off of the fuel prefilter (4) and insert a new filter.	
3	Insert the fuel prefilter back into the tank.	
4	Close the fuel cap.	
5	Bleed the fuel system (see chapter 6.5 <i>Venting the fuel system</i> , page 37).	

Changing the main fuel filter

Overview

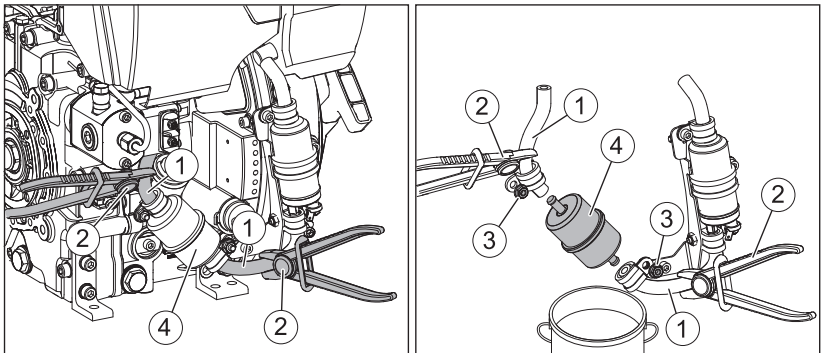

1	Fuel feed line
2	Hose clip
3	Hexagon nut
4	Main fuel filter

Procedure

Step	Activity
1	Block the fuel supply line (1) upstream and downstream of the main fuel filter (4) using hose clips (2).

Step	Activity
2	Place a suitable container under the main fuel filter (4) to collect emerging fuel.
3	Unscrew the hexagon nuts (3).
4	Pull off the fuel supply line (1) on both sides of the main fuel filter (4). Dispose of the main fuel filter according to the local environmental regulations.
5	Insert a new main fuel filter. Observe the flow-through direction (arrows).
6	Attach the main fuel filter to the holder using hexagon nuts (3) and then release the fuel supply line again for use.
7	Bleed the fuel system (see chapter 6.5 <i>Venting the fuel system, page 37</i>).
8	Start the engine and perform a test run.
9	After test run, check the fuel filter for leak tightness.

8.2.11 Maintaining the dry air filter



NOTICE



- Immediately clean the filter cartridge if the maintenance display appears at maximum speed.
- Always renew the filter cartridge after a use period of 250 operating hours.

Installing and removing the filter cartridge

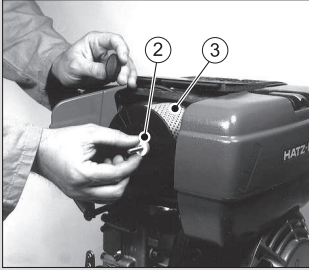
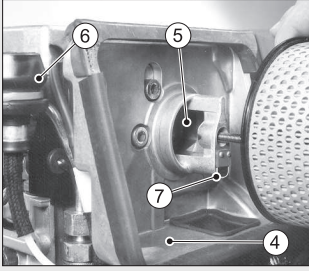

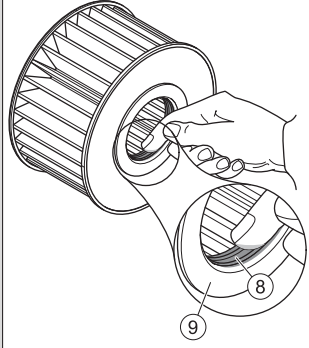

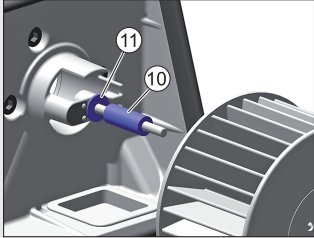

Step	Activity	Figure
1	Unscrew the air filter cover (1).	

Step	Activity	Figure
2	Unscrew the knurled nut (2) and remove the air filter cartridge (3).	
3	Clean the filter housing (4) and cover for the air filter. Ingress of dirt or other foreign bodies into the intake opening (5) of the engine absolutely must be avoided.	
4	In the model with an air filter maintenance indicator (6), check the condition and cleanliness of the valve shim (7).	
5	The air filter cartridge either needs to be replaced, or cleaned or checked depending on the degree of contamination (see chapter 8.2.12 <i>Checking and cleaning the air filter cartridge</i> , page 77).	
6	Thinly coat the gasket (8) with grease or engine oil to make assembly and disassembly of the air filter cartridge easier. Do not coat the face side (9).	

Step	Activity	Figure
7	Before installing the air filter cartridge, ensure that the spacer bush (10) is installed. In engine types 1B50E, the washer (11) is also installed.	
8	Assembly is performed in the reverse order.	

8.2.12 Checking and cleaning the air filter cartridge

Safety notes

 CAUTION	
	<p>Danger of injury.</p> <p>When working with compressed air, foreign bodies may fly into your eyes.</p> <ul style="list-style-type: none"> ▪ Wear safety goggles. ▪ Never direct the compressed air jet toward people or toward yourself.
	
 CAUTION	
	<p>Danger of injury.</p> <p>When blowing out the filter cartridge, the ambient air becomes contaminated with dust.</p> <ul style="list-style-type: none"> ▪ This dust may contain harmful particles. ▪ Wear a fine dust mask.
NOTICE	
	<ul style="list-style-type: none"> ▪ The pressure must not exceed 5 bar. ▪ Even minor damage in the areas of the sealing surface, filter paper or filter cartridge makes it impossible to reuse the filter cartridge.

Checking and cleaning the air filter cartridge

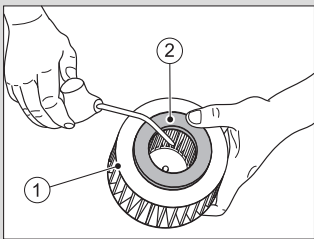
Step	Activity	Figure
Dry contamination		
1	Blow out the filter cartridge (1) with dry compressed air from the inside to the outside until dust no longer emerges.	
2	Check the sealing surface (2) of the filter cartridge for damage.	
3	Check the filter cartridge for cracks in the filter paper and other damage by holding it against the light at a slant or letting light from a lamp shine through it.	
4	Replace the filter cartridge if necessary (see note).	
Moist or oily contamination		
1	Renew the filter cartridge.	

9 Faults

9.1 Troubleshooting

General troubleshooting notes

If the cases listed below have been worked through but the fault continues to persist, please contact your nearest **Hatz service station**.

The engine fault indicator on the HATZ instrument box lights up during operation.

Possible causes	Remedy	Chapter
Various errors in different assemblies.	Use the flash code table to identify and eliminate errors.	<i>9.2 Flash code table for engine faults, page 83</i>

The engine does not start or is difficult to start, but can be turned easily as usual

Possible causes	Remedy	Chapter
The tank ran out of fuel during operation.	Add fuel.	<i>7.6 Refueling, page 48</i>
Fuel filter is clogged.	Change the fuel filter.	<i>8.2.10 Changing the fuel filter, page 72</i>
Electrical fuel pump is not working.	Check the cabling.	
Injection nozzle is not functional.	Contact HATZ service.	
Insufficient compression:		
▪ Wrong tappet clearance.	Check the tappet clearance and adjust if necessary.	<i>8.2.6 Checking and setting the tappet clearance, page 64</i>
▪ Cylinder and/or piston ring wear.	Contact HATZ service.	
Model with diesel particulate filter:		
Diesel particulate filter is clogged.	Contact HATZ service.	

At low temperatures (engine does not start)

Possible causes	Remedy	Chapter
Pre glow system (option) defective.	Contact HATZ service.	
Fuel gelled due to insufficient cold resistance.	Check whether the fuel that emerges from the fuel feed line is clear and not cloudy. If the fuel has gelled, either thaw the engine or drain the entire fuel supply system, and change the fuel filter. Fill with a temperature-resistant fuel mixture.	<i>4.4 Fuel, page 25</i> <i>8.2.10 Changing the fuel filter, page 72</i>
Oil is too viscous and causes a too low starter speed.	Change the engine oil. Add engine oil with a suitable viscosity class.	<i>8.2.4 Change the engine oil, page 58</i>
Insufficiently charged battery.	Check the battery and contact the service center if necessary.	<i>3.2.4 Electrical equipment, page 18</i>
Machine is not uncoupled.	If possible, separate the engine from the machine by uncoupling it.	

The starter does not switch on and the engine does not turn.

Possible causes	Remedy	Chapter
Irregularities in the electrical equipment:		
Battery and/or other cable connections are incorrectly connected.	Check the electrical equipment and its components or contact Hatz service.	<i>3.2.4 Electrical equipment, page 18</i>
Cable connections are loose and/or oxidized.		
Battery is defective and/or not loaded.		
Defective starter.		
Defective relay, monitoring elements etc.		

Engine switches off spontaneously during operation

Possible causes	Remedy	Chapter
Engine malfunction (indicator for engine malfunction flashes).	Use the flash code table to identify and eliminate errors.	<i>9.2 Flash code table for engine faults, page 83</i>
The tank ran out of fuel during operation.	Fill with fuel.	<i>7.6 Refueling, page 48</i>
Fuel filter is clogged.	Change the fuel filter.	<i>8.2.10 Changing the fuel filter, page 72</i>
Tank vent is clogged.	Ensure that the tank is sufficiently vented.	
Electrical defects.	Check the wiring or contact HATZ service.	
Mechanical faults.	Contact HATZ service.	

The engine loses power and speed

Possible causes	Remedy	Chapter
<ul style="list-style-type: none"> ▪ The engine is running in emergency mode due to a malfunction (engine malfunction indicator is lit) 	Switch off the engine and use the flash code table to identify and eliminate errors.	<i>9.2 Flash code table for engine faults, page 83</i>
<ul style="list-style-type: none"> ▪ The tank ran out of fuel during operation. 	Add fuel.	<i>7.6 Refueling, page 48</i>
<ul style="list-style-type: none"> ▪ Fuel filter is clogged. 	Change the fuel filter.	<i>8.2.10 Changing the fuel filter, page 72</i>
<ul style="list-style-type: none"> ▪ Inadequate tank venting. 	Ensure that the tank is sufficiently vented.	
Model with diesel particulate filter:		
Diesel particulate filter is clogged.	Contact HATZ service.	

The engine loses power and speed, and black smoke emerges from the exhaust

Possible causes	Remedy	Chapter
Dirty air filter unit.	Check the degree of dirt contamination of the air filter, and clean or renew if necessary.	8.2.11 <i>Maintaining the dry air filter, page 75</i>
Tappet clearance not OK.	Adjust the tappet clearance.	8.2.6 <i>Checking and setting the tappet clearance, page 64</i>
Injection nozzle not OK.	Contact HATZ Service.	
Model with diesel particulate filter:		
In engines with a diesel particulate filter, black smoke only comes out of the exhaust pipe if the diesel particulate filter is faulty.	Contact HATZ Service.	

The engine is unexpectedly running at a low speed. It is not possible to increase the engine speed.

Possible causes	Remedy	Chapter
Engine malfunction (indicator for engine malfunction is lit).	Use the flash code table to identify and eliminate errors.	9.2 <i>Flash code table for engine faults, page 83</i>

Engine becomes very hot. Indicator lamp for engine temperature (option) lights up

Possible causes	Remedy	Chapter
Too much engine oil in the engine.	Drain the engine oil to the upper mark of the dipstick.	7.5 <i>Check the oil level, page 46</i>
Inadequate cooling:		
<ul style="list-style-type: none"> ▪ Contamination in the entire area of the cooling air guides. 	Clean the cooling air area.	8.2.7 <i>Cleaning the cooling air area, page 67</i>
<ul style="list-style-type: none"> ▪ Incompletely closed air guide parts. 	Check the air guide parts and shafts for completeness and good sealing properties.	

Unusual noises in the exhaust area

Possible causes	Remedy	Chapter
Model with diesel particulate filter:		
Diesel particulate filter is faulty.	Contact HATZ service.	

Condensate emerges from the exhaust silencer

Possible causes	Remedy	Chapter
Operation under no load or very low load for an extended period.	Operate the machine at a load of approx. 70 % if possible until the exhaust outlet is dry again.	

9.2 Flash code table for engine faults

If an engine malfunction occurs, the indicator for "Engine malfunction" lights up (see *Explanation of symbols*, chapter 5.2 *HATZ instrument box*, page 30). If the engine is switched off and the starting key is set to "I", a flashing signal is output on the engine control indicator. The table below shows possible flashing signals, their meaning, as well as measures for remedies.

If the listed fault cases have been worked through but the fault continues to persist, please contact your nearest **HATZ Service**.

The diagrams show the structure of a flash code using flash codes 2 and 3 as examples:

Flash code 2

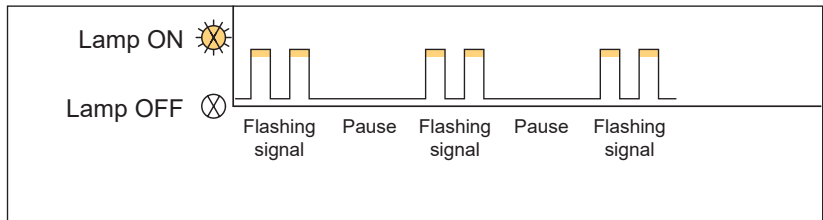

Flash code 3

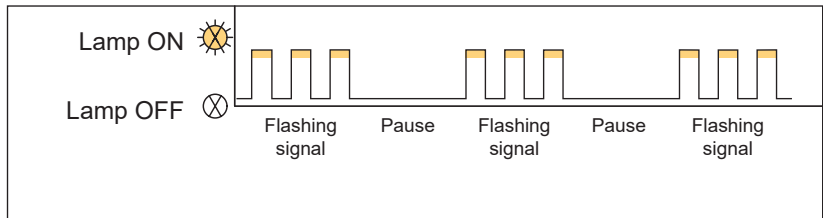

The light flashes three times in a row for each error. If two or more errors are active, these are flashed immediately afterwards. To repeat, turn the starting key to position "0" and then back to position "I". The flash code is deleted automatically if the error does not reoccur within two operating cycles (= start/operation/stop).







Flash code table

Flashing signal	Possible causes	Remedy	Section
1 <i>Area affected:</i> Engine oil pressure	Engine oil pressure too low.	Check the oil level.	<i>7.5 Check the oil level, page 46</i>
2 <i>Area affected:</i> Overtemperature	Engine temperature is too high.	Clean the cooling air area.	<i>8.2.7 Cleaning the cooling air area, page 67</i>
	Oil temperature too high.	Reduce the engine load.	
3 <i>Area affected:</i> Charge control	Faulty voltage controller.	Contact HATZ service.	
	Battery voltage too high.	Contact HATZ service.	
	Battery voltage too low.	Check the electrical equipment and its components or contact Hatz service.	
	Speed control is faulty.	Contact HATZ service.	
	Supply voltage for sensors is faulty.	Check the cabling.	
4 <i>Area affected:</i> Analog setpoint or CAN communication	Cabling is faulty.	Check the cabling.	
	Speed control is faulty.	Contact HATZ service.	
5 <i>Area affected:</i> Ambient pressure sensor	Sensor is faulty.	Contact HATZ service.	

Flashing signal	Possible causes	Remedy	Section
6 <i>Area affected:</i> Maintenance interval indicator	The 250-hour service is due.	Perform all maintenance work as per the maintenance plan. After the maintenance work is completed, reset the maintenance interval indicator using the Hatz Diagnostics Software HDS ² or HDS ² light. If necessary, contact Hatz service.	
7 <i>Area affected:</i> Fuel pump, glow plug, injection pump	Cabling is faulty.	Check the cabling.	
	Fuel pump, glow plug or injection pump is faulty.	Contact HATZ service.	
8 <i>Area affected:</i> Speed sensor system	Cabling to the crankshaft speed sensor is faulty.	Check the cabling.	
	Crankshaft speed sensor is faulty.	Contact HATZ service.	
	Engine speed is impermissibly high.	Contact HATZ service.	
9 <i>Area affected:</i> Control unit	Cabling to the control unit is faulty.	Check the cabling.	
	Faulty control unit.	Contact HATZ service.	

9.3 Start support

Safety notes

 DANGER	
	<p>Danger of explosion due to the generation of sparks.</p> <p>When carrying out the start support, a battery can generate an explosive gas mixture.</p> <ul style="list-style-type: none">▪ Avoid fire, sparks, open flames and smoking.▪ Avoid short-circuits.▪ Only connect battery terminals with identical polarity (see <i>Overview</i> section).▪ Always observe the sequence described for connecting and disconnecting the start support cable.▪ Do not place tools or other metal objects on the battery.
 WARNING	
  	<p>Danger of chemical burns.</p> <p>Battery acid is highly corrosive and can cause eye and skin injuries.</p> <ul style="list-style-type: none">▪ Wear safety goggles and safety gloves.



WARNING

Danger of injury or property damage due to incorrectly carried out start support.

If the instructions for the start support are not adhered to precisely, there is a danger of explosion due to the generation of sparks as well as a danger of chemical burns due to leaking battery acid.



- Follow the notice and warning labels on the battery.
- Do not use a charger unit with Boost function. Electrical components could be destroyed due to overvoltage.
- Use a suitable start support cable with insulated cable pliers.

Required line cross-section:

- 12 volts min. 50 mm²
- Never swap the positive (+) and negative (-) battery terminals (danger of short circuit).
- Make sure that the start support cables are laid in such a way that they cannot be damaged by rotating parts or become disconnected from the battery terminals.
- A discharged battery and current emitting battery must have the same voltage (12 volts). The battery capacity should be about the same.
- A discharged battery can freeze even at temperatures just a few degrees below zero. If the battery is frozen or thawed, do not carry out a start support. Replace the battery.

Overview – 12 volt model

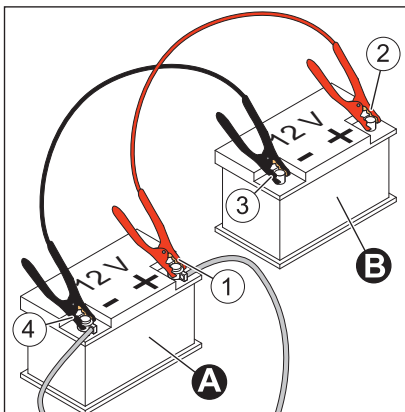

Battery	
A	Discharged battery
B	Current emitting battery
Red start support cable (positive (+) terminal)	
1	Clamp pliers on the positive (+) terminal of the discharged battery
2	Clamp pliers on the positive (+) terminal of the current emitting battery
Black start support cable (negative (-) terminal)	
3	Clamp pliers on the negative (-) terminal of the current emitting battery
4	Clamp pliers on the negative (-) terminal of the discharged battery

Procedure – 12 volt model

Step	Activity
1	A second battery (12 volts) or an external device with a 12 volt system can be used for the start support. See also the instructions in the documentation for the external device.
2	Turn the starting key to position "0" on both machines.
3	Connect the batteries using the clamp pliers of the start support cable in the sequence 1–2–3–4 (see <i>Overview – 12 volt model</i>).
4	Do not start the external device.
5	Start the machine with the discharged battery.
6	Let the engine run for several minutes.
7	Disconnect the start support cable in the sequence 4–3–2–1.







9.4 Emergency hand start

The series engine is equipped with an electric start mechanism. An emergency hand start system that can be used to start the equipment by hand can be installed additionally as an option. An emergency hand start should only be performed if an electric start is not possible, e.g. when the battery is weak.

This chapter contains the following subchapters:

- **Safety notes**
- **Prerequisite for performing an emergency hand start**
- **Performing tests**
- **Emergency hand start with recoil start**

Safety notes

 DANGER	
	<p>Danger to life from inhaling exhaust gases.</p> <p>Toxic engine exhaust gases can lead to loss of consciousness, and even death, in closed-off and poorly ventilated rooms.</p> <ul style="list-style-type: none"> ▪ Never operate the machine in closed-off or poorly ventilated rooms. ▪ Do not breathe in the exhaust gases.
 WARNING	
	<p>Danger of injury from faulty starter rope.</p> <p>A chafed starter rope can rip and cause injuries.</p> <ul style="list-style-type: none"> ▪ Before using the starter rope, check for abrasion; replace the rope if necessary.
 CAUTION	
	<p>Danger of injury from the use of starting fluid.</p> <ul style="list-style-type: none"> ▪ Danger of injury during emergency hand start because the use of starting fluid can result in uncontrolled ignitions. ▪ Never use starting fluid.

Prerequisite for performing an emergency hand start

- The battery has enough residual voltage left that the charge control, oil pressure indicator and engine fault indicator light up in starting key position I (operation) (see also chapter 5.2 *HATZ instrument box, page 30*).
- The operator must have a powerful build and must not have any medical restrictions. The emergency hand start system may not be operated by children or by people with a less powerful build.
- Wear safety shoes and closed work clothing (see chapter *Personal protective equipment, chapter 3.2.1 Operational safety, page 12*).
- Ambient temperature: 5 °C or higher

NOTICE	
	<p>An emergency hand start is not possible if the fuel tank is empty.</p> <p>If the fuel tank has been run empty, the fuel system will need to be bled after being refilled using the electric fuel pump (see chapter 6.5 <i>Venting the fuel system, page 37</i>).</p> <p>After bleeding, multiple start attempts with the starter are necessary to start the engine.</p>

Performing tests

Procedure

Step	Test
1	The machine is standing securely and on a level surface.
2	The installation location is adequately ventilated.
3	There is a sufficient amount of fuel in the fuel tank (see chapter 7.6 <i>Refueling, page 48</i>).
4	There is a sufficient amount of engine oil in the engine housing (see chapter 6.4 <i>Filling engine oil (first filling), page 36</i>).
5	Starter rope of the recoil start without chafing.
6	No persons are located in the danger zone of the engine or machine.
7	All safety equipment is in place.

Emergency hand start with recoil start

Overview

Standard (instrument box attached on the engine)

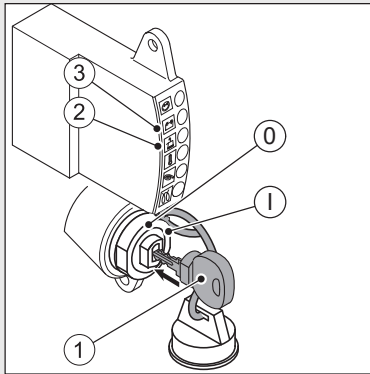

Option (external instrument box)

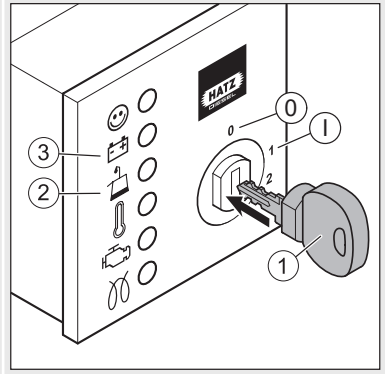

1	Starting key
2	Oil pressure indicator
3	Charge control

Ignition lock

0	Off
I	Operation

Recoil start

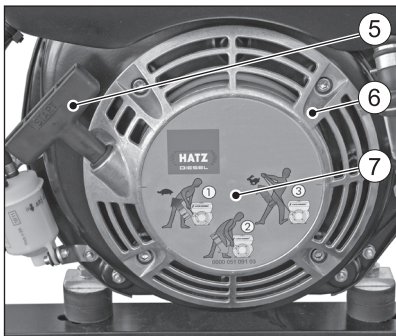

5	Grip
6	Recoil start cover

7 Diagram of starting procedure

Procedure



Step	Activity
1	Insert the starting key (1) all the way and turn to position "I". The oil pressure indicator and charge control light up.
2	Assume a sturdy position. The surface you are standing on must not be slippery.
3	Secure lightweight devices with your foot.
4	Pull the grip (5) with the rope through slowly and let it run back in. This activates the electric fuel pump for 10 seconds. If the engine does not start within these 10 seconds, repeat the procedure.
5	Slowly pull out the grip (5) with the rope until you encounter slight resistance.
6	Let the rope run back in to be able to use the entire rope length for the starting procedure.
7	Hold the grip with both hands.

Step	Activity
8	<p>Pull the starting rope evenly and with increasing speed (do not tear at it jerkily) until the engine starts.</p> <p><i>Note:</i> If the engine does not start, the starting process can be repeated by performing steps 2–8.</p>
9	<p>The oil pressure indicator and charge control must go out after the engine is started.</p>

10 Storage and disposal

10.1 Storing the machine

Safety notes



DANGER



Danger to life from inhaling exhaust gases.

Toxic engine exhaust gases can lead to loss of consciousness, and even death, in closed-off and poorly ventilated rooms.

- Never operate the machine in closed-off or poorly ventilated rooms.
- Do not breathe in the exhaust gases.



DANGER



Fire hazard from fuel.

Leaked or spilled fuel can ignite on hot engine parts and cause serious burn injuries.

- Only refuel when the engine is switched off and has cooled down.
- Never refuel in the vicinity of open flames or sparks that can cause ignition.
- Do not smoke.
- Do not spill fuel.



CAUTION



Danger of environmental damage from spilled fuel.

Do not overfill the fuel tank and do not spill fuel.

- Collect any leaking fuel and dispose of it according to local environmental regulations.

NOTICE



Comply with the safety chapter!

Follow the basic safety instructions in chapter 3 *Safety*, page 7.

Storing the machine for a lengthy period

Take the following measures if you intend to take the machine out of service for a lengthy period (3-12 months):

Step	Activity
1	Drain the fuel tank until it is nearly empty and fill with FAME*-free fuel. Operate the engine for a few minutes so that only FAME-free fuel is still in the fuel system.
2	Change the engine oil (see chapter 8.2.4 <i>Change the engine oil</i> , page 58).
3	Change the fuel filter (see chapter 8.2.10 <i>Changing the fuel filter</i> , page 72).
4	Let the machine cool down.
5	Remove the battery in accordance with the Operator's Manual for the machine and store at ambient temperature. Comply with the local regulations as well as the regulations of the battery manufacturer for the storage of batteries.
6	Close and seal all engine openings (air intake openings, air outlet openings and the exhaust gas opening) so that no foreign bodies can enter, but a small amount of air can still be exchanged. This avoids condensation.
7	After the machine has cooled down, cover it to protect it against dust, and store it in a dry and clean place.

*FAME = Fatty Acid Methyl Ester

Ambient conditions during storage

- Max. permissible storage temperature: -25 °C to +60 °C
- Max. permissible humidity: 70%
- Protect the engine from direct sunlight

Recommissioning

Step	Activity
1	Remove all covers.
2	Check the cables, hoses and lines for cracks and leak tightness.
3	Check the engine oil level.
4	Install the battery in accordance with the Operator's Manual for the machine.

The brand new engine can normally be stored for up to 12 months. The protection lasts up to approx. 6 months at very high humidity and in sea air.

For storage periods of more than 12 months, please contact the nearest **HATZ Service**.

10.2 Disposing of the machine

Disposal information

Dispose of the machine (including machine parts, engine oil and fuel) according to the local disposal regulations and the environmental laws in the country of use.

Because of the danger of possible environmental damage, only permit an approved specialist company to dispose of the machine.

NOTICE



When the machine has reached the end of its lifecycle, ensure that it is disposed of safely and properly, especially parts and substances that can be dangerous to the environment. These also include fuel, lubricants, plastics, and batteries (if present).

- Do not dispose of the battery with the household trash.
- Dispose of the battery at a collection point for possible recycling.

11 Declaration of incorporation

Extended Declaration of Incorporation EC Machinery Directive 2006/42/EC

The manufacturer: **Motorenfabrik Hatz GmbH & Co.KG**
Ernst-Hatz-Straße 16
94099 Ruhstorf a. d. Rott (Germany)

hereby declares that the incomplete machine: product description: **Hatz diesel engine**

Type designation and as of serial number:

1B20=10034; 1B20V=11124; 1B20R=14413

1B30=10129; 1B30V=11220; 1B30E=18204; 1B30VE=18303

1B40=11019;

1B50=12416; 1B50V/W=12616; 1B50E=18405; 1B50E=18805

satisfies the following basic safety and health protection requirements in acc. with Annex I to the above-mentioned Directive.

- Annex I, General principles no. 1

- No. 1.1.2., 1.1.3., 1.1.5., 1.2.1., 1.2.2., 1.2.3., 1.2.4.1., 1.2.4.2., 1.2.6, 1.3.1., 1.3.2., 1.3.3., 1.3.4., 1.3.7., 1.3.9., 1.4.1., 1.5.1., 1.5.3., 1.5.8., 1.5.9., 1.5.10, 1.5.11, 1.6.1., 1.6.2., 1.6.4., 1.7.

All relevant basic safety and health protection requirements down to the interfaces described

in the manual for diesel engine

in the enclosed data sheets

in the enclosed technical documents

have been complied with.

The following standards have been applied (fully or in part):

- EN 1679-1: 092011

- EN ISO 12100: 032011

- EN ISO 13857: 062008

- EN 60204-1: 062007

The manual for the diesel engine has been attached to that of the incomplete machine and the Assembly Instructions have been provided to the customer electronically together with the order confirmation.

The special technical documents in acc. with Annex VII B of the Directive 2006/42/EC have been prepared. If necessary, I will submit the above-mentioned special technical documents in electronic form to the competent authority.

The above-mentioned special technical documents can be requested from:
 Wolfgang Krautloher, address, see manufacturer

Commissioning is prohibited until it has been established, where applicable, that the machine into which the above-mentioned incomplete machine is to be incorporated, satisfies the provisions of the Machinery Directive.

19/10/2021

Date

 Maximilian Eder
 Series manager air-cooled engines

 Dr.-Ing. Simon Thierfelder
 Chief Technical Officer - CTO

12 Declaration of the manufacturer

The following "Manufacturer's declaration of compliance with regulation (EU) 2016/1628" only applies to engines with an engine family designation in accordance with chapter 1.5 (see next page).

The corresponding engine family designation is noted on the engine type plate (see chapter 4.2 *Engine type plate*, page 23).

CO₂ emissions*

Engine family designation	CO ₂ g/kWh	Test cycle	Parent engine	Speed
1B30E/1B50E-cs	1066.24	NRSC-D2	1B50E	3600
1B30E/1B50E-vs	918.00	NRSC-C1	1B50E	3600
1B50E-vs	914.46	NRSC-C1	1B50E	3600

*According to EU Regulation 2016/1628, Article 43 Paragraph (4)

Declaration by manufacturer on compliance with Regulation (EU) 2016/1628

The undersigned: Manfred Wührmüller, Head of Quality Management GMQ

Hereby declares that the following engine type/engine family (*) complies in all respects with the requirements of Regulation (EU) 2016/1628 of the European Parliament and of the Council ⁽¹⁾, Commission Delegated Regulation (EU) 2017/654 ⁽²⁾, Commission Delegated Regulation (EU) 2017/655 ⁽³⁾ and Commission Implementing Regulation (EU) 2017/656 ⁽⁴⁾ and does not use any defeat strategy.

All emission control strategies comply, where applicable, with the requirements for Base Emission Control Strategy (BECS) and Auxiliary Emission Control Strategy (AECS) set-out in section 2 of Annex IV to Delegated Regulation (EU) 2017/654, and have been disclosed in accordance with that Annex and with Annex I to Implementing Regulation (EU) 2017/656.

- 1.1. Make (trade name(s) of manufacturer): **Hatz**
- 1.2. Commercial name(s) (if applicable): **Hatz-Diesel**
- 1.3. Company name and address of manufacturer:
Motorenfabrik Hatz GmbH & Co. KG, Ernst-Hatz-Str. 16, 94099 Ruhstorf a.d. Rott
- 1.4. Name and address of manufacturer's authorised representative (if any): –
- 1.5. Engine type designation/ engine family designation/ FT (*):
1B30E/1B50E-vs, 1B30E/1B50E-cs und 1B50E-vs

(Place) (Date):

Ruhstorf den 16.12.19

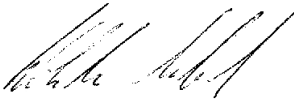

-
- ⁽¹⁾ Regulation (EU) 2016/1628 of the European Parliament and of the Council of 14 September 2016 on requirements relating to gaseous and particulate pollutant emission limits and type-approval for internal combustion engines for non-road mobile machinery, amending Regulations (EU) No 1024/2012 and (EU) No 167/2013, and amending and repealing Directive 97/68/EC (OJ L 252, 16.9.2016, p. 53).
 - ⁽²⁾ Commission Delegated Regulation (EU) 2017/654 of 19 December 2016 supplementing Regulation (EU) 2016/1628 of the European Parliament and of the Council with regard to technical and general requirements relating to emission limits and type-approval for internal combustion engines for non-road mobile machinery (OJ L 102, 13.4.2017, p. 1).
 - ⁽³⁾ Commission Delegated Regulation (EU) 2017/655 of 19 December 2016 supplementing Regulation (EU) 2016/1628 of the European Parliament and of the Council with regard to monitoring of gaseous pollutant emissions from in-service internal combustion engines installed in non-road mobile machinery (OJ L 102, 13.4.2017, p. 334).
 - ⁽⁴⁾ Commission Implementing Regulation (EU) 2017/656 of 19 December 2016 laying down the administrative requirements relating to emission limits and type-approval of internal combustion engines for non-road mobile machinery in accordance with Regulation (EU) 2016/1628 of the European Parliament and of the Council (OJ L 102, 13.4.2017, p. 364).
 - ⁽⁵⁾ Regulation (EU) No 910/2014 of the European Parliament and of the Council of 23 July 2014 on electronic identification and trust services for electronic transactions in the internal market and repealing Directive 1999/93/EC (OJ L 257, 28.8.2014, p. 73).

The following explanation only applies for engines with engine type number **190** and an engine family designation as per section 1.5. For details on the engine type number, see *4.2.1 Engine serial number, page 24*. The corresponding engine family designation is noted on the engine type plate (see chapter *4.2 Engine type plate, page 23*).



Declaration of the manufacturer on compliance with Regulation (EU) 2016/1628

The signees: Jakob Reif and Dr. Andreas Stadler

herewith declare that the following engine type/engine family (*) complies in all respects with the requirements of Regulation (EU) 2016/1628 of the European Parliament and of the Council (1), Commission Delegated Regulation (EU) 2017/654 (2), Commission Delegated Regulation (EU) 2017/655 (3) and Commission Implementing Regulation 2017/656 (4) and does not use defeat devices.

All emission reduction strategies, where applicable, comply with the requirements of the standard emission reduction strategy and the supplementary emission reduction strategy set out in Section 2 of Annex IV to Delegated Regulation (EU) 2017/654 on technical and general requirements and have been disclosed in accordance with that Annex and with Annex I to Implementing Regulation (EU) 2017/656 on administrative requirements.

- 1.1. Trademark (manufacturer trademark(s)): **Hatz**
- 1.2. Trade name(s) (if any): **Hatz-Diesel**
- 1.3. Manufacturer company name and address:
Motorenfabrik Hatz GmbH & Co. KG, Ernst-Hatz-Str. 16, 94099 Ruhstorf a.d.Rott
- 1.4. If applicable, name and address of the authorized representative of the manufacturer: ---
- 1.5. Engine type designation/engine family designation/ET (*) **1B50E-vs**

Place, date, Jakob Reif, Head of Quality Assurance

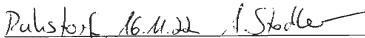
Place, date, Dr. Andreas Stadler, Head of Thermodynamics

Signature (or visual representation of an "advanced electronic signature" in compliance with Directive (EU) No. 910/2014 of the European Parliament and of the Council (5), including the signature test data):

(*) Cross out choices that are unused or indicate only the choices used

(1) Regulation (EU) 2016/1628 of the European Parliament and of the Council of 14 September 2016 on the requirements relating to emission limit values for gaseous and particulate pollutants and the type-approval of internal combustion engines to be installed in non-road mobile machinery, amending Regulations (EU) No 1024/2012 and (EU) No 167/2013, and amending and repealing Directive 97/68/EC (OJ L 252, 16.09.2016, p. 53).

(2) Commission Delegated Regulation (EU) 2017/654 of 19 December 2016 supplementing Regulation (EU) 2016/1628 of the European Parliament and of the Council on technical and general requirements concerning emission limits and type-approval of internal combustion engines to be installed in non-road mobile machinery (OJ L 102, 13.04.2017, p. 1).

(3) Commission Delegated Regulation (EU) 2017/655 of 19 December 2016 supplementing Regulation (EU) 2016/1628 of the European Parliament and of the Council on the monitoring of emissions of gaseous pollutants from in-service internal combustion engines to non-road mobile machinery (OJ L 102, 13.04.2017, p. 334).

(4) Commission Implementing Regulation (EU) 2017/656 of 19 December 2016 laying down the administrative requirements for emission limit values and type-approvals for internal combustion engines to be installed in non-road mobile machinery pursuant to Regulation (EU) 2016/1628 of the European Parliament and of the Council (OJ L 102, 13.04.2017, p. 364).

(5) Regulation (EU) No 910/2014 of the European Parliament and of the Council of 23 July 2014 on electronic identification and trust services for electronic transactions in the internal market and repealing Directive 1999/93/EC (OJ L 257, 28.08.2014, p. 73).

Motorenfabrik Hatz GmbH & Co. KG

Ernst-Hatz-Str. 16

94099 Ruhstorf a. d. Rott

Deutschland

Tel. +49 8531 319-0

Fax. +49 8531 319-418

marketing@hatz-diesel.de

www.hatz-diesel.com



CREATING POWER SOLUTIONS.

0000 436 014 03 - 12.2023

Printed in Germany

EN