

CREATING POWER SOLUTIONS.

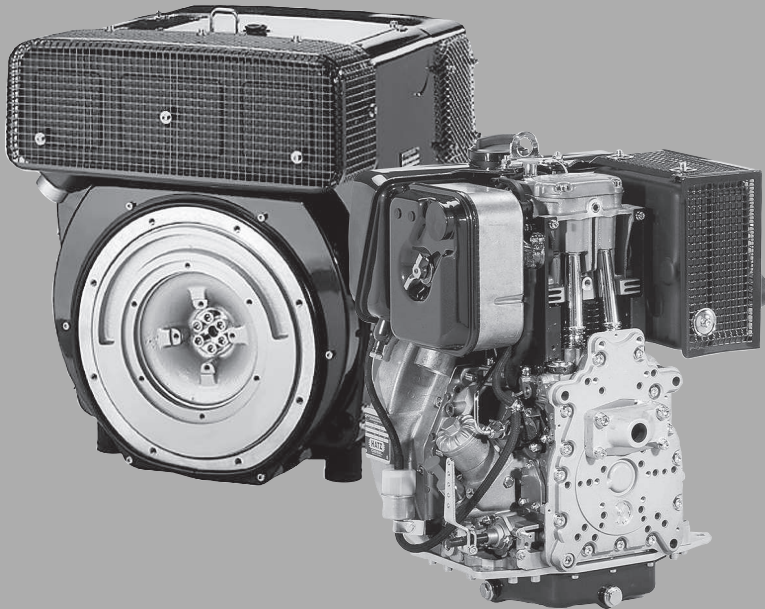

1D42. | 1D50. | 1D81. | 1D90.

MANUAL for diesel engine

Hatz Diesel

www.hatz-diesel.com

1	Legal notices	5
2	General information	6
3	Safety	7
3.1	General information.....	7
3.1.1	Intended use	7
3.1.2	Machine user or machine manufacturer obligations	8
3.1.3	Representation of safety notes	9
3.1.4	Meaning of safety symbols.....	10
3.2	Safety notes	12
3.2.1	Operational safety	12
3.2.2	Machine-specific safety instructions for operation	15
3.2.3	Machine-specific safety instructions for maintenance work	16
3.2.4	Electrical equipment.....	18
3.3	Labels.....	20
4	Technical data	22
4.1	Engine information and filling quantities	22
4.2	Engine type plate	23
4.3	Physical operating conditions.....	24
4.4	Engine oil	25
4.5	Fuel	26
5	Engine overview	27
5.1	Designation of components.....	27
6	Transport, installation and commissioning	30
6.1	Transport.....	30
6.2	Installation notes	32
6.3	Preparations for commissioning.....	33
6.4	Filling engine oil (first filling).....	33
6.5	Filling the oil bath air filter (option)	35
7	Operation and use	36
7.1	Safety notes	36
7.2	Performing tests	37
7.3	Start preparation	38
7.3.1	Activating automatic decompression.....	38
7.3.2	Activating the mechanical oil pressure shut down device (option):.....	39
7.3.3	Setting the speed control	42
7.4	Starting the engine	43
7.4.1	Starting the engine with crankhandle.....	44
7.4.2	Starting the engine when cold.....	47
7.4.3	Starting the engine with a starter	48
7.5	Switching off the engine	51

7.5.1	Switching off the engine (mechanical)	52
7.5.2	Switching off the engine (electrical)	53
7.6	Check the oil level	54
7.6.1	Engine oil level	55
7.6.2	Oil level in the oil bath air filter (option)	57
7.7	Refueling	58
7.8	Checking the water separator	60
7.9	Check the air filter warning indicator (option)	62
8	Maintenance	63
8.1	General maintenance instructions	63
8.2	Maintenance work	64
8.2.1	Maintenance notice label	65
8.2.2	Maintenance plan	66
8.2.3	Checking the intake area of the combustion air	67
8.2.4	Checking the cooling air area	69
8.2.5	Changing the engine oil and oil filter	71
8.2.6	Cleaning the oil bath air filter (option)	76
8.2.7	Checking and setting the tappet clearance	79
8.2.8	Cleaning the cooling air area	82
8.2.9	Check the screw connections	83
8.2.10	Changing the fuel filter	84
8.2.11	Maintaining the dry air filter	87
8.2.12	Checking and cleaning the air filter cartridge	89
9	Faults	91
9.1	Troubleshooting	91
10	Storage and disposal	97
10.1	Storing the machine	97
10.2	Disposing of the machine	99
11	Declaration of incorporation	100
12	Declaration of the manufacturer	101

1 Legal notices

Contact data

© 2023
 Motorenfabrik Hatz
 Ernst-Hatz-Straße 16
 94099 Ruhstorf
 Germany
 Tel. +49 (0)8531 319-0
 Fax +49 (0)8531 319-418
 marketing@hatz-diesel.de
 www.hatz-diesel.com
 All rights reserved!

Copyright

The copyright for this manual rests entirely with Motorenfabrik HATZ, Ruhstorf.

This manual may only be copied or distributed if written approval has been received. This also applies to the copying or distribution of excerpts of this manual. The same conditions apply to distribution of this manual to third parties in digital form.

Original manual

This manual has been translated into multiple languages.

The German version is the **original manual**. All other language versions are **translations** of the **original manual**.

Revision

Version	Date	Name
18 - Rev. 00	25.10.2023	GMV / ef

2 General information

Information on the document

This manual was created with due care. It is exclusively intended to offer a technical description of the machine and to provide instructions on commissioning, operating and maintaining the machine. When operating the machine, the applicable standards and legal regulations as well as any in-house regulations apply.

Before commissioning, during operation and before maintenance work is begun on the machine, read this manual carefully and keep it close by for ready access.

Machine

This manual describes the following machine.

Machine name	HATZ diesel engine
Type number	1D42, 1D50, 1D81, 1D90

Customer service

Have service work performed by qualified technicians only. We recommend that you work with one of the over 500 **HATZ service stations**. Trained specialists there will repair your machine with **Hatz original spare parts** and with **HATZ tools**. The global HATZ service network is at your disposal to advise you and supply you with spare parts. For the address of the **Hatz service station** nearest you, please see the enclosed spare parts list or visit us in the Internet at: **www.hatz-diesel.com**

Installation of unsuitable spare parts can lead to problems. We cannot accept liability for direct damage or secondary damage that results from this.

We therefore recommend the use of **Hatz original spare parts**. These parts are manufactured according to strict Hatz specifications and achieve maximum operational reliability through their perfect fit and functionality. The order number can be found in the enclosed spare parts list or on the Internet at: **www.hatz-diesel.com**

Exclusion of liability

The manufacturer cannot be held liable for personal injury, damage to property or damage to the machine itself caused by improper use, foreseeable misuse, or failure to follow or adequately follow the safety measures and procedures described in this manual. This also applies to changes made to the machine and the use of unsuitable spare parts.

Modifications, which serve the technical improvements, are reserved.

3 Safety

3.1 General information

Introduction

This chapter contains the information you need to work safely with this machine.

To prevent accidents and damage to the machine, it is imperative that these safety instructions be followed.

Read this chapter carefully before beginning work.

3.1.1 Intended use

Intended use

The machine described in this manual fulfills the following functions:

- Diesel engine intended for installation in a machine or for assembly with other machines to form a machine. See chapter *11 Declaration of incorporation, page 100*.

This engine is intended exclusively for the purpose specified and tested by the manufacturer of the machine in which the engine is installed.

Any other use is not intended and therefore not permitted. Violations compromise the safety of the personnel working with the machine. Motorenfabrik HATZ does not accept any liability for damage resulting from this.

The operational safety of the machine is only guaranteed if it is used as intended.

Use according to the intended purpose also includes observance of the instructions in this Operator's Manual

Foreseeable misuse

The following is considered to be foreseeable misuse:

- Any use that varies from or extends beyond the uses specified above.
- Failure to comply with the instructions given in this manual.
- Failure to comply with the safety instructions.
- Failure to immediately eliminate malfunctions that impact safety before continuing work with the machine (working with the machine when it is not in perfect condition, either functionally or in terms of safety).
- Failure to perform the necessary inspection and maintenance work.
- Any unauthorized modification of or removal of safety equipment.
- Use of spare parts and accessories that are unsuitable or have not been approved by HATZ.
- Fuel other than specified in the instructions.
- Operation in flammable or hazardous environments.

- Operation in closed-off or poorly ventilated rooms.
- Operation in an aggressive atmosphere (e.g., high salt content) without further measures for corrosion protection.
- Improper operation at variance with DIN ISO 3046 -1 and DIN ISO 8528 (climate, load, safety).

Residual risks

Residual risks result during daily use and in association with maintenance work.

These residual risks will be pointed out in chapter 3.2.2 *Machine-specific safety instructions for operation, page 15* and in chapter 3.2.3 *Machine-specific safety instructions for maintenance work, page 16* as well as in the further contents of the manual, directly in front of the descriptions or operating instructions concerned.

3.1.2 Machine user or machine manufacturer obligations

Machine manufacturer obligations

If you have an engine that is not yet installed in a machine, it is imperative that you follow the **Assembly Instructions for HATZ Diesel Engines** before installing the engine. These assembly instructions contain important information on how to safely install the engine and are available at your nearest **HATZ service station**.

It is prohibited to start the engine before it is fully installed.

In addition, please note that it is prohibited to start up the machine before it has been determined that the machine into which this engine is installed fulfills all safety-related requirements and legal regulations.

User obligations

The operator is obliged to only operate the machine when it is in perfect condition. The operator must check the condition of the machine before use and ensure that any defects are eliminated before it is taken into service. Running the machine while identified defects exist is not permitted. The operator must also ensure that all persons who work on the machine are familiar with the contents of this manual, .

Obligations of the operating and maintenance personnel

Personnel assigned with operating and maintaining the machine must have read and understood this manual or must possess the qualifications necessary for working with this equipment, acquired in training/instructional courses. No one may work with the machine without the necessary qualifications, even if for just a brief period.

The operating and maintenance personnel must not be under the influence of drugs, medication or alcohol.

All work performed on the machine must be in compliance with the information provided in this manual.

Storing this manual

This manual is an integral component of the machine (also when being sold). It must be stored in the direct vicinity of the machine and be accessible to personnel at all times.

3.1.3 Representation of safety notes

Overview

This machine has been designed and built according to state-of-the-art technology and the recognized safety standards. Despite these precautions, risks exist when operating the machine and during maintenance work.

These risks are identified in this manual by means of safety notes.

The safety notes precede the relevant description or operating step.

Structure of the safety notes

The safety notes consist of:

- Danger symbol
- Signal word
- Description of the danger
- Possible consequences
- Preventative measures



General danger symbol



The general danger symbol is used to identify the danger of personal injury.

Signal words





Signal words identify the magnitude of the risk and the seriousness of possible injury:

Danger symbol/ signal word	Meaning
 DANGER	This signal word is used to indicate imminently dangerous situations which, if not avoided, will lead to serious injury or death.
 WARNING	This signal word is used to indicate potentially dangerous situations which, if not avoided, may lead to serious injury or death.
 CAUTION	This signal word is used to indicate potentially dangerous situations which, if not avoided, may lead to minor or moderate injury.
CAUTION	This signal word, without a danger symbol, is used to indicate the risk of property damage.
NOTICE	This signal word indicates additional useful information, such as operating tips and cross references.

3.1.4 Meaning of safety symbols

Explanation of symbols

The following table describes the meanings of the safety symbols used in this manual.

Symbol	Meaning
	Smoking, fire, and open flames are prohibited!
	Warning of personal injury!
	Warning of hot surfaces!
	Warning of hot surfaces! (Alternative)



Symbol	Meaning
	Warning of flammable substances!
	Warning of explosive substances!
	Warning of toxic engine exhaust!
	Warning of corrosive substances!
	Warning of heavy loads!
	Warning of environmental damage!
	Comply with this manual or additional documentation from other manufacturers or the operator.
	Additional information that is useful to the reader.

3.2 Safety notes

3.2.1 Operational safety

Introduction

This chapter contains all of the important safety instructions for personal protection and for safe and reliable operation. Additional, task-related safety instructions can be found at the beginning of each chapter.

 DANGER	
	<p>Danger to life, danger of injury or danger of property damage due to failure to comply with this manual and the safety instructions contained therein.</p> <ul style="list-style-type: none">▪ As the operator of the machine, you must ensure that all people working on the machine are familiar with the content of this manual.▪ Before working on the machine, read this manual carefully, paying special attention to the safety notes.▪ Fulfill all required safety conditions before working on the machine.▪ Follow all general safety instructions as well as the specific task-related safety instructions contained in the individual chapters.

Using the machine







- Only operate the machine for the purposes described in chapter 3.1.1 *Intended use*, page 7.

Compliance with other regulations

- The applicable regulations of the relevant professional associations must be observed.
- Comply with the regulations concerning the minimum safety and health requirements for the use of work equipment by workers at work.
- In addition, local safety, accident prevention and environmental regulations also apply when operating the machine.

Personal protective equipment

During operation and maintenance of the machine, personal protective equipment must be available and must be used if necessary. The use of personal protective equipment is specified in the description of the operating steps.

Personal protective equipment	Pictogram	Function
Safety shoes		Safety shoes offer protection against: <ul style="list-style-type: none"> ▪ Slipping ▪ Falling objects
Hearing protection		Hearing protection offers protection against ear injuries due to excessive and constant noise.
Safety gloves		Safety gloves protect the hands against injury, e.g., from battery acid.
Safety goggles (with side protection)		Safety goggles protect the eyes from flying objects (e.g., dust particles, spraying liquids, spraying acid).
Fine dust mask		A fine dust mask protects the wearer against particulate pollutants.
Working clothes		Wear close-fitting working clothes. It must not restrict the wearer's freedom of movement, however.

Warning labels and information signs on the machine

The warning labels and information signs on the machine must be followed (see chapter "Labels" 3.3 *Labels*, page 20).

The warning labels and information signs must be kept legible and must be replaced if necessary. For this purpose, contact your nearest **HATZ service station**.

Maintenance work









Maintenance work that goes beyond the scope described in this manual must only be performed by qualified technicians (see chapter 2 *General information*, page 6).

Independent maintenance work and constructional changes to the machine, especially to the safety equipment, are not permitted.

Safety equipment

Safety equipment must not be modified and must not be rendered ineffective during normal operation.

General safety instructions

 DANGER	
	<p>Danger to life and danger of injury due to failure to follow the warnings on the machine and in this manual.</p> <ul style="list-style-type: none"> ▪ Heed the warnings on the machine and in this manual.
 WARNING	
	<p>Danger of injury and danger of incorrect operation due to inadequate personnel qualifications.</p> <ul style="list-style-type: none"> ▪ The personnel must have read and understood this manual or must possess the qualifications necessary for working with this equipment, acquired in training/instructional courses. ▪ Only qualified personnel is permitted to operate and maintain this machine. ▪ Failure to comply will cause the warranty to become void.
 WARNING	
	<p>Danger of injury from failure to follow the Operating Instructions and from performing unauthorized tasks on the machine.</p> <ul style="list-style-type: none"> ▪ Follow all instructions. ▪ Do not perform activities for which no qualification is available. Contact properly trained personnel if necessary.
 CAUTION	
	<p>Danger of injury from overloading the body.</p> <p>Lifting the machine to transport it or to move it to another location can lead to injuries (of the back, for example).</p> <ul style="list-style-type: none"> ▪ Only lift the machine with a hoist (see chapter 6.1 <i>Transport</i>, page 30).

3.2.2 Machine-specific safety instructions for operation

Introduction

The machine can pose residual risks during operation. To eliminate these risks, all persons working on the machine must follow the general and machine-specific safety instructions.

If you have an engine that is not yet installed in a machine, it is imperative that you follow the **Assembly Instructions for HATZ Diesel Engines** before installing the engine.

These Assembly Instructions contain important information on safe installation.

If the engine is installed in a machine or assembled with other machines to form a machine, it is prohibited to start the engine before it has been determined that the newly created machine fulfills all safety-related requirements and applicable legal regulations.



Safe operation







- Before switching on the machine, ensure that no one can be injured when the machine is started up.
- During machine operation, ensure that unauthorized persons do not have access to the area in which the machine has an impact.
- Parts of the exhaust gas system and the surface of the engine become hot during operation. Risk of injury from touching hot parts! Let the engine cool before maintenance.
- Do not refuel during operation.

Faults

- Immediately eliminate faults that compromise safety.
- Switch off the machine and do not take into service again until all faults have been eliminated.

Safety instructions for operation

 DANGER	
	<p>Danger to life from inhaling exhaust gases.</p> <p>Toxic engine exhaust gases can lead to loss of consciousness, and even death, in closed-off and poorly ventilated rooms.</p> <ul style="list-style-type: none"> ▪ Never operate the machine in closed-off or poorly ventilated rooms. ▪ Do not breathe in the exhaust gases.

 DANGER	
	<p>Danger of fire from hot exhaust gas system.</p> <p>If inflammable materials come into contact with the exhaust gas flow or the hot exhaust gas system, these materials can ignite.</p> <ul style="list-style-type: none"> ▪ Keep inflammable materials away from the exhaust gas system. ▪ Do not operate the engine (exhaust flow or hot exhaust gas system) in the direct vicinity of combustible materials.
 DANGER	
 	<p>Fire hazard from fuel.</p> <p>Leaked or spilled fuel can ignite on hot engine parts and cause serious burn injuries.</p> <ul style="list-style-type: none"> ▪ Only refuel when the engine is switched off and has cooled down. ▪ Never refuel in the vicinity of open flames or sparks that can cause ignition. ▪ Do not smoke. ▪ Do not spill fuel.
 CAUTION	
	<p>Danger of injury from defective crank handle.</p> <p>A damaged or broken handle bar can cause injuries. A worn drive dog can slip out of the starting mechanism when starting and also cause injuries.</p> <ul style="list-style-type: none"> ▪ Check the crank handle for a broken handle bar, worn drive dog etc.; replace if necessary.

3.2.3 Machine-specific safety instructions for maintenance work

Introduction

The machine can pose residual risks during maintenance. To eliminate these risks, all persons working on the machine must follow the general and machine-specific safety instructions.

Maintenance intervals

- Strictly adhere to the maintenance intervals.
- Check the safety equipment regularly to ensure it is in good condition and functioning properly.
- Check connections, cables and fasteners regularly to ensure they are in good condition.

Maintenance work

Maintenance work that goes beyond the scope described in this manual must only be performed by qualified technicians. We recommend that you work with one of the over 500 **HATZ service stations**.





Replacing parts





- When replacing defective components, we recommend that you use **Hatz original spare parts** (see chapter 2 *General information, page 6*).
- When disposing of parts that can no longer be used, do so in accordance with local environmental regulations or send them to a recycling center.

Measures following maintenance and troubleshooting

- Securely reconnect loose electrical connections; check that the electrical components and equipment are functioning properly.
- Check the entire machine for foreign bodies; remove any foreign bodies.



Safety instructions for maintenance work

 DANGER	
	<p>Danger of explosion from flammable cleaning agents.</p> <p>Cleaning with benzene is an explosion hazard. It is highly flammable, can become electrostatically charged, and can generate an explosive gas/air mixture.</p> <ul style="list-style-type: none"> ▪ Use halogen-free, cold cleaners with a high flash point for cleaning. ▪ Comply with manufacturer's instructions.
 WARNING	
 	<p>Danger of injury from compressed air and dust particles.</p> <p>Eye injuries can occur when cleaning with compressed air.</p> <ul style="list-style-type: none"> ▪ Wear safety goggles.

 CAUTION	
	<p>Danger of injury from ignoring the maintenance instructions.</p> <ul style="list-style-type: none"> ▪ Only perform maintenance work when the engine is switched off. ▪ Protect start-up devices (crank handle, recoil start or starting key) from unauthorized access. ▪ For engines with a starter: Disconnect the negative battery terminal. ▪ When the maintenance work has been completed, ensure that all tools are removed from the machine.
 CAUTION	
	<p>Danger of burns.</p> <p>There is a danger of burns when working on a hot engine.</p> <ul style="list-style-type: none"> ▪ Let the engine cool before maintenance.

3.2.4 Electrical equipment

Safety notes

 DANGER	
	<p>Danger to life, danger of injury or danger of property damage due to incorrect use of batteries.</p> <ul style="list-style-type: none"> ▪ Do not place tools or other metal objects on the battery. ▪ Before performing work on the electrical equipment, always disconnect the negative battery terminal. ▪ Never swap the plus (+) and negative (–) battery terminals. ▪ When installing the battery, first connect the plus cable and then the negative cable. ▪ When removing the battery, first disconnect the negative cable and then the plus cable. ▪ It is imperative to prevent short circuits and mass contact of current carrying cables. ▪ If faults occur, check the cable connections for good contact.

**DANGER****Danger of explosion from flammable substances.**

There is a danger of explosion from flammable gases.

- Keep batteries away from open flames and incendiary sparks.
- Do not smoke when working with batteries.

**CAUTION****Danger of chemical burns**

Chemical burns can occur when using batteries for the electrical operation.

- Protect your eyes, skin, and clothing from corrosive battery acid.
- Immediately rinse areas affected by splashed acid with clear water and consult a physician if necessary.

NOTICE

- We cannot be held liable for electrical equipment that is not designed according to HATZ wiring diagrams.

- Promptly replace faulty indicator lamps.
- Do not pull out the starting key during operation.
- Do not disconnect the battery while the machine is running. Resulting voltage peaks could destroy the electronic components.
- When performing a manual emergency start, leave the (possibly depleted) battery connected.
- When cleaning, do not spray the electrical equipment components with a water jet or high pressure cleaner.
- When performing welding work on the machine, disconnect the battery and place the ground clamp of the welding equipment as close as possible to the welding area. Disconnect the plug-in connections to the voltage regulator.
- For emergency operation without a battery, turn the starting key on the instrument box to position 0 before starting.

3.3 Labels

Warning labels and information signs on the engine

Label	Meaning
	<p>Maintenance instructions (see chapter 8.1 <i>General maintenance instructions</i>, page 63)</p>
	<p>CAUTION! Danger of injury on the guide sleeve of the starting mechanism.</p> <ul style="list-style-type: none"> Do not reach into the guide sleeve of the starting mechanism while the engine is running.
	<p>CAUTION! Damage from noise and insufficient engine cooling.</p> <ul style="list-style-type: none"> Only operate the engine when all covers are installed.
	<p>Crankhandle start:</p> <ol style="list-style-type: none"> Engine stopped. Actuate the decompression lever. After engaging the automatic decompression on the end stop, five crank handle turns are required until the engine compresses again and can ignite.

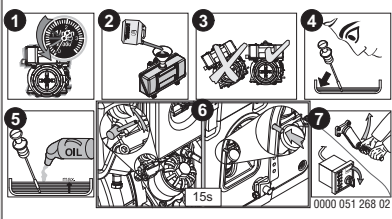
Label	Meaning
	<p>Refuel with diesel fuel only. For the specification, see chapter 4.5 <i>Fuel</i>, page 26</p>
	<p>Mechanical oil pressure shut down device (option):</p> <ol style="list-style-type: none"> 1. Engine has switched off automatically. 2. Fill with fuel. 3. Make sure the engine is horizontal. 4. Check the oil level. 5. Top up engine oil if required. 6. Press manual lever for approx. 15 seconds. For engines with a fuel feed pump, simultaneously actuate the manual lever on the fuel feed pump several times. 7. Start the engine. <p>For more information, see chapter 7.3.2 <i>Activating the mechanical oil pressure shut down device (option)</i>; page 39.</p>

Warning labels and information signs on the crank handle

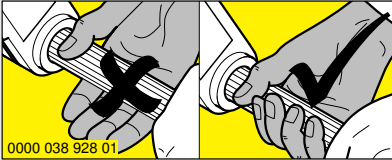
Label	Meaning
	<p>Hold the handle bar so that it cannot twist and quickly turn the crank so that continuous traction between the engine and crank is ensured, see chapter 7.4.1 <i>Starting the engine with crankhandle</i>, page 44.</p>

4 Technical data

4.1 Engine information and filling quantities

Type		1D42	1D50	1D81	1D90
Model		S, Z	S, Z	S, Z, C	S, Z, C
Type		Air cooled, four stroke diesel engine			
Combustion system		Direct injection			
Number of cylinders		1	1	1	1
Bore/Stroke	mm	90 / 70	97 / 70	100 / 85	104 / 85
Displacement	cm ³	445	517	667	722
Engine oil consumption (after run-in period)	Approx.	1 % of fuel consumption, pertaining to full load			
Engine oil pressure at oil temperature of 80–120 °C	Min.	0.6 bar at 850 rpm			
Sense of rotation		When viewing flywheel: left			
Tappet clearance at 10–30°C					
Inlet	mm	0.10	0.10	0.10	0.30
Outlet	mm	0.20	0.20	0.20	0.30
Permissible inclination ¹⁾	Max.	30°	30°	25°	25°
Weight					
Model S	Approx. kg	78	83	105	106
Model Z	Approx. kg	81	85	107	108
Model C	Approx. kg	–	–	126	127
Battery capacity	Max.	12 V – 88 Ah / 640 A (EN) / 700 A (SAE)			
		24 V – 55 Ah / 420 A (EN) / 450 A (SAE)			

Model **S**: non-encapsulated, normal counter balance

Model **Z**: non-encapsulated, additional counter balance

Model **C**: SILENT PACK, additional counter balance

¹⁾ The values apply to continuous operation in any direction.
Exceeding these limit values causes engine damage.

Engine oil capacities

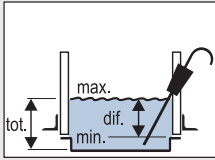
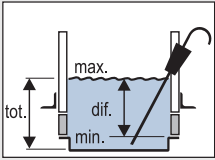
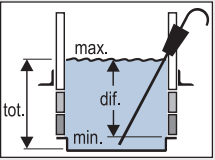
	Oil sump					
	Standard		1 adapter ring		2 adapter rings	
						
Type	tot. ltr. ³⁾	dif. ltr. ⁴⁾	tot. ltr. ³⁾	dif. ltr. ⁴⁾	tot. ltr. ³⁾	dif. ltr. ⁴⁾
1D42 S/Z	1.2	0.4	2.8	2.0	4.4	3.6
1D50 S/Z	1.5	0.5	–	–	–	–
1D81 S/Z	1.9	0.9	3.2	2.2	4.5	3.5
1D81 C	1.9	0.9	–	–	–	–
1D90 S/Z	1.9	0.9	3.2	2.2	4.5	3.5
1D90 C	1.9	0.9	–	–	–	–

³⁾ **tot. ltr.:** engine oil capacity (in liters) for the first filling or oil change.
For engines without an oil filter, the filling quantities are reduced by approx. 0.1 liter.

⁴⁾ **dif. ltr.:** Oil refill quantity (in liters) between the "min" and "max" marking on the dipstick.

These values are approximations only. The max. mark on the dipstick is decisive in any case (see section 7.6 *Check the oil level*, page 54).

4.2 Engine type plate

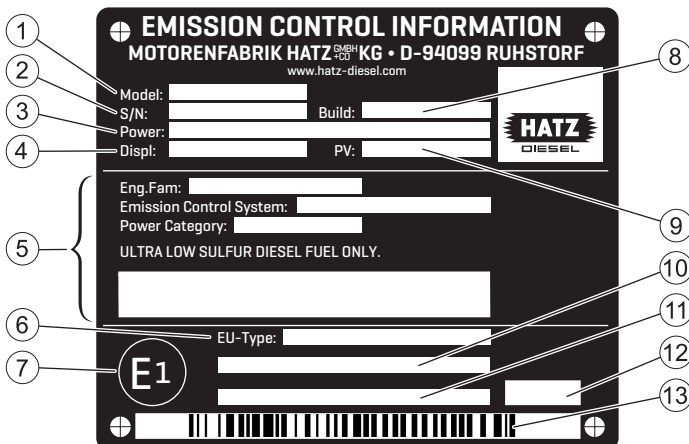

The engine type plate is located on the crankcase or noise reduction capsule and contains the following engine information:

1	Model designation of the engine
2	Engine serial number
3	Engine power (kW) at rated speed (rpm)
4	Displacement (liters)
5	Information for US emission certification (EPA/CARB)
6	EU type approval number
7	EU country of origin (Germany)
8	Model year (month/year)
9	Test specification for special settings
10	Engine family designation or exemption code (EM) or transition code (TM) according to regulation (EU) 2016/1628
11	Additional specifications according to Regulation 2017/656 (exceptions) or "Separate shipment information"
12	Code for type plate variant
13	Barcode (engine serial number)

The following data must always be specified in case of queries and for spare parts orders:

1	Model designation
2	Engine serial number
3	Rated speed (rpm)

4.3 Physical operating conditions

Engine adjustment

The engine is normally adjusted to operate within the standard reference conditions stipulated in ISO 3046-1:

Parameter	Unit	Value
Intake air temperature	°C	+25
	K	298
Relative humidity	%	30
Air pressure (at approx. 100 meters above sea level)	kPa	100

NOTICE

If the machine is operated at high altitudes and high temperatures, adjustment of the engine setting may be necessary if the climatic conditions were not taken into account when the machine was ordered. If this is the case, please contact your nearest **HATZ service station**.

4.4 Engine oil

Oil quality

All oil brands that meet at least one of the following specifications are suitable:

- **ACEA – B3 / E4** or better
- **API – CF / CH-4** or better

If engine oils of a low quality standard are used, the oil change interval must be reduced to 150 operating hours.

Oil viscosity

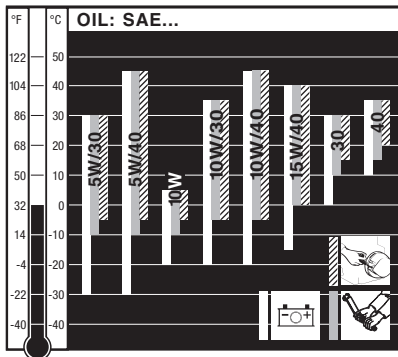

Choose the recommended viscosity based on the type of start (recoil, crank handle or electric) and on the engine temperature at which the engine will be operated.

CAUTION

Engine damage from unsuitable engine oil.

Unsuitable engine oil considerably reduces engine service life. Only use engine oil that fulfills the specifications stipulated above.

4.5 Fuel

Fuel type

All types of diesel fuel that meet the minimum requirements of the following specifications are suitable:

- **Europe: EN 590**
- **UK: BS 2869 A1 / A2**
- **USA: ASTM D 975-09a 1-D S15 or 2-D S15**
- **USA: ASTM D 975-09a 1-D or 2-D ¹⁾**

¹⁾ Only suitable for engines without engine family designation on the engine type plate. For details, see chapter 12 *Declaration of the manufacturer, page 101*.

CAUTION	
	<p>Danger of engine damage from low quality fuel.</p> <p>The use of fuel that does not meet the specifications can lead to engine damage.</p> <ul style="list-style-type: none"> ▪ The use of fuels that do not meet specifications require approval by Motorenfabrik HATZ (main plant).

CAUTION	
	<p>Danger of malfunctions due to old fuel.</p> <p>When diesel fuel is stored in a fuel tank or canister for lengthy periods, deposits may form on account of fuel aging. These deposits result in malfunctions due to clogged fuel filters and damage to the injection system.</p> <ul style="list-style-type: none"> ▪ Perform the prescribed storage steps in machines that will be out of use for more than three months (see chapter 10.1 <i>Storing the machine, page 97</i>). ▪ Only refuel with fresh diesel fuel such as can be obtained from filling stations.

Winter fuel

Diesel fuel loses its fluidity at low temperatures, which can lead to operating problems. Use cold-resistant winter diesel fuel for outside temperatures below 0 °C.

5 Engine overview

5.1 Designation of components

Standard model – 1D42, 1D50, 1D81, 1D90 S/Z

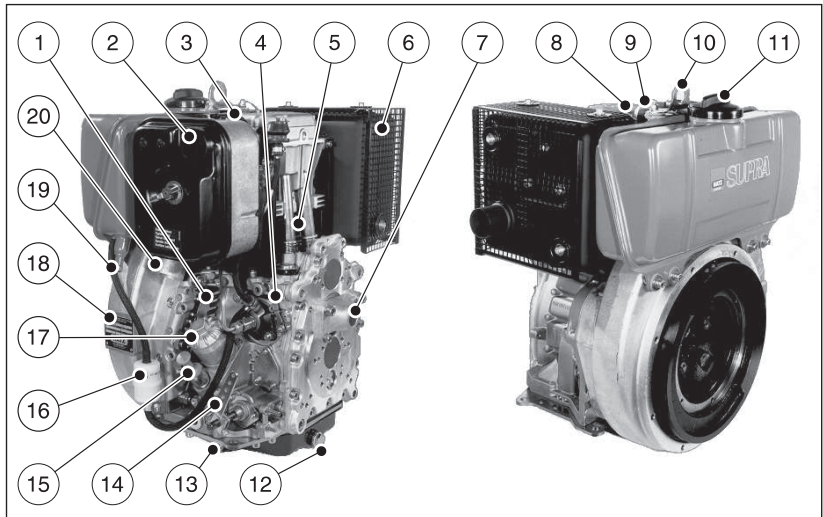

Pos.	Designation
1	Intake opening for cooling air
2	Dry air filter
3	Decompression lever (for hand start)
4	Stop lever (option)
5	Coolant air outlet
6	Silencer with contact protection
7	Guide sleeve for starting handle
8	Cylinder head cover
9	Cold-start oil metering device (option)
10	Lifting eye
11	Fuel cap
12	Oil drain screw (front)
13	Oil drain screw (side)
14	Speed control lever
15	Oil filling opening and dipstick

Pos.	Designation
16	Fuel filter
17	Oil filter (option)
18	Type plate
19	Water separator
20	Intake opening for combustion air

Encapsulated model "Silent Pack" – 1D81C, 1D90C

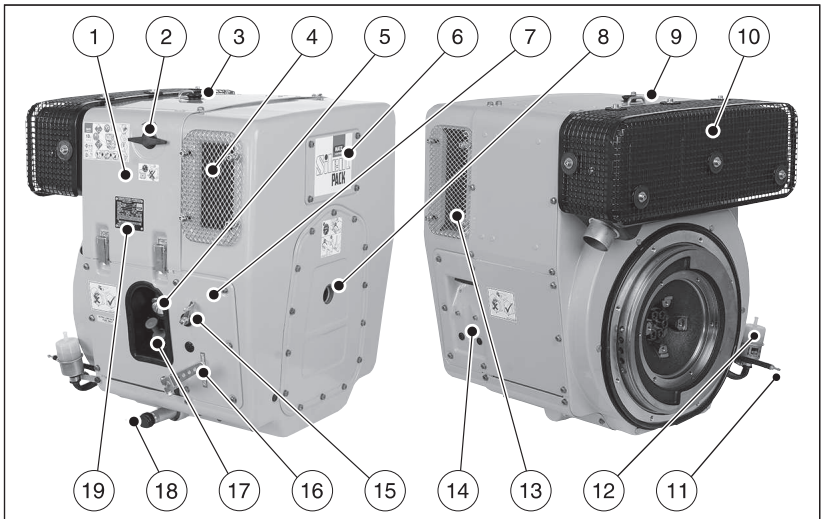

Pos.	Designation
1	Access cover to air filter
2	Decompression lever (for hand start)
3	Cold-start oil metering device (option)
4	Intake opening for combustion air and cooling air
5	Oil filter (option)
6	Cleaning opening
7	Side trim panel
8	Opening for crank handle (for hand start)
9	Lifting eye
10	Silencer (encapsulated)

Pos.	Designation
11	Fuel return line
12	Fuel filter
13	Coolant air outlet
14	Battery connection and central connector for electrical equipment (option)
15	Stop lever (option)
16	Speed control lever
17	Oil filling opening and dipstick
18	Oil drain screw
19	Type plate

6 Transport, installation and commissioning

6.1 Transport

Safety notes



WARNING



Danger of injury from improper lifting and transport.

Danger of crushing from the engine falling or tipping.

- Only use the lifting eye already mounted on the machine for lifting.
- Before lifting the engine, check the lifting eye for damage. Lifting with a damaged lifting eye is not permitted. Replace a damaged lifting eye before using it for lifting.
- Only use a suitable hoist with a sufficient carrying capacity.
- Do not remain under suspended loads.



CAUTION



Only use the lifting eye for transporting the engine.

Do not use for lifting the entire machine.



CAUTION



Danger of injury from overloading the body.

Lifting the machine to transport it or to move it to another location can lead to injuries (of the back, for example).

- Only lift the machine with a hoist.

NOTICE



Danger of environmental damage from leaking fluid.

If the machine is tilted, engine oil and fuel can run out.

- Only transport the machine in an upright position.

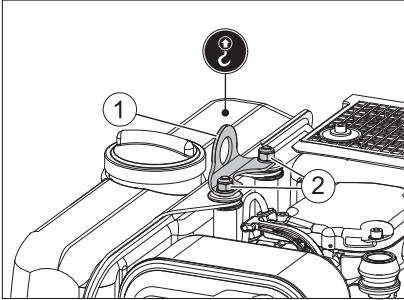
Overview – lifting eye (standard model 1D42, 1D50, 1D81, 1D90 S/Z)

1	Lifting eye (lifting point)
2	Fastening nuts for lifting eye

Procedure

Step	Activity
1	Ensure that the lifting eye (1) is not damaged.
2	Ensure that the fastening nuts (2) are tight. Then lift the engine.

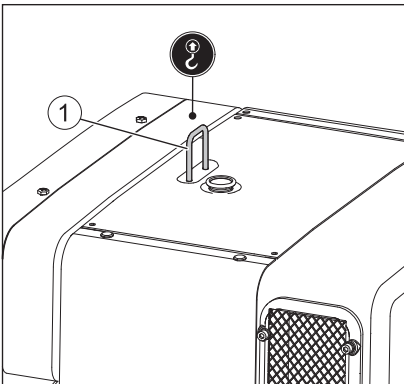
Overview – lifting eye (encapsulated model 1D81C, 1D90C)

1	Lifting eye (lifting point)
---	-----------------------------

Procedure

Step	Activity
1	Ensure that the lifting eye (1) is not damaged. Then lift the engine.

Transport conditions

- When transporting the machine, follow the safety instructions.
- When transporting, follow the applicable safety and accident prevention regulations.
- After delivery, check the machine for completeness and transport damage.
- Only transport the machine when it is switched off and has cooled down.
- If you have questions on transporting the machine, please contact your nearest **HATZ service station**. For contact data, see chapter 1 *Legal notices*, page 5 or **www.hatz-diesel.com**.

6.2 Installation notes

HATZ diesel engines are efficient, robust, and have a long service life. Therefore, they are usually installed in machines that are used for commercial purposes.

The machine manufacturer must follow the applicable regulations regarding machine safety – the engine is a part of a machine.

Depending on the use and installation of the engine, it may be necessary for the machine manufacturer and machine user to install safety equipment to prevent inappropriate use. Note the following:

- Parts of the exhaust gas system and the engine surface become hot during operation and may not be touched until they cool down after the engine is switched off.
- Incorrect cable connections and incorrect operation of the electrical equipment can lead to sparking and must be avoided.
- After the engine is installed in the machine, rotating parts must be protected against contact.
HATZ safety equipment is available for the belt drive of the cooling fan and alternator.
- Comply with all notices and warning labels on the engine and keep them in a legible condition. If an adhesive label should become detached or difficult to read, it must be replaced promptly. For this purpose, contact your nearest **HATZ service station**.
- Any improper modification of the engine will result in a loss of liability coverage for resulting damage.



Only regular maintenance, as specified in this manual, will maintain the operating readiness of the engine.

The **assembly instructions** contain important information on how to safely assemble the engine. They are available from any **Hatz service station**.

If you have any questions, please contact your nearest **HATZ Service** before commissioning the engine.

6.3 Preparations for commissioning



- Check the delivered parts for completeness, damage, and other noticeable issues.
- Ensure that the setup location is adequately ventilated.

 DANGER	
	<p>Danger to life from inhaling exhaust gases.</p> <p>Toxic engine exhaust gases can lead to loss of consciousness, and even death, in closed-off and poorly ventilated rooms.</p> <ul style="list-style-type: none"> ▪ Never operate the machine in closed-off or poorly ventilated rooms. ▪ Do not breathe in the exhaust gases.

6.4 Filling engine oil (first filling)

Engines are normally delivered without an engine oil filling.

Safety note

 CAUTION	
 	<p>Danger of injury</p> <p>Prolonged contact with engine oil can lead to irritation of the skin.</p> <ul style="list-style-type: none"> ▪ Wear safety gloves. ▪ If there is contact with the skin, thoroughly wash the affected areas of the skin with soap and water.

CAUTION	
	<p>Danger of later engine damage.</p> <ul style="list-style-type: none"> ▪ Operating the engine with an oil level below the min. mark or above the max. mark can lead to engine damage. ▪ When checking the oil level, the engine must be horizontal and have been switched off for a few minutes.

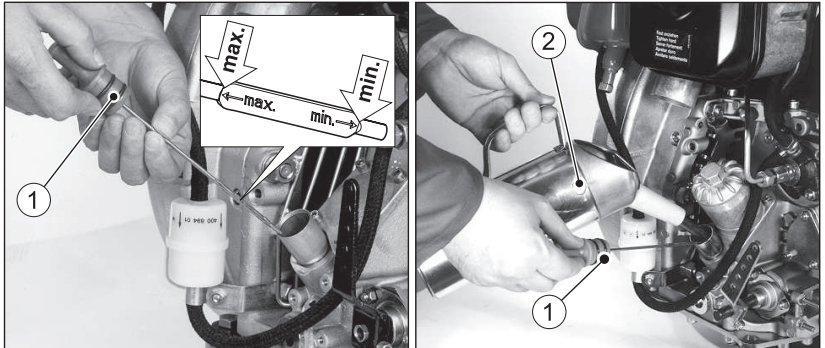
Overview – Standard version 1D42, 1D50, 1D81, 1D90 S/Z

1	Dipstick
2	Oil refilling container

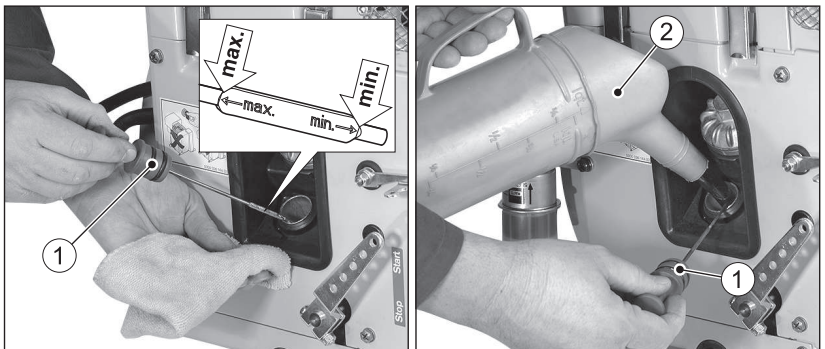
Overview – Encapsulated model 1D81C, 1D90C

1	Dipstick
2	Oil refilling container

Procedure

Step	Activity
1	Pull out the dipstick (1) and clean it.
2	Fill engine oil. For the specification and viscosity, see chapter 4.4 <i>Engine oil</i> , page 25. For the filling quantity, see chapter 4.1 <i>Engine information and filling quantities</i> , page 22.
3	Reinsert the dipstick.

Step	Activity
4	Pull out the dipstick and check the oil level.
5	If required, add engine oil to the max. mark.
6	Reinsert the dipstick.

6.5 Filling the oil bath air filter (option)

Overview

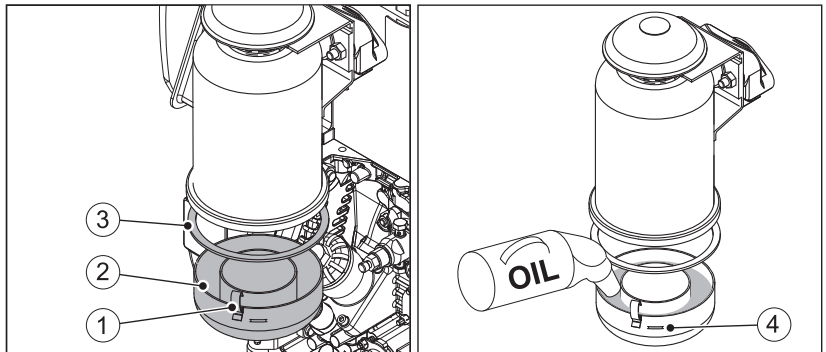

1	Clamp fastener (2x opposing)
2	Oil container
3	Seal ring
4	Level mark

Procedure

Step	Activity
1	Release the clamp fasteners (1).
2	Remove the oil container (2).
3	Fill the oil container with engine oil up to the level mark (4).
4	Mount the oil container, ensuring that the gasket (3) is properly positioned and the clamp fasteners (1) are correctly fastened.

7 Operation and use

7.1 Safety notes

NOTICE



Comply with the safety chapter!

Follow the basic safety instructions in chapter 3 *Safety*, page 7.



WARNING



Danger of injury from damage and defects on the machine.

- Do not take the machine into service if damage has been localized and identified.
- Replace defective components.



WARNING



Danger of injury from failure to follow the operating instructions and from performing unauthorized tasks on the machine.

- Define the responsibilities of the personnel taking the machine into service.
- Replace defective machine parts immediately.
- Check the installation conditions when the machine is first taken into service and after the machine has been inactive for a lengthy period.

CAUTION

Danger of engine damage from low load operation.

Operating the engine at no load or at very low load for an extended period can impair the running characteristics of the engine.

- Make sure that the engine load is at least 15 %.
- Before switching off the engine following low load operation, briefly operate it at a considerably higher load.

CAUTION

If the force applied to the speed control lever and stop lever exceeds permissible levels, this may cause damage to the stops and inside regulator parts.

Please note the following picture.

Max. permissible forces at the speed control and stop levers

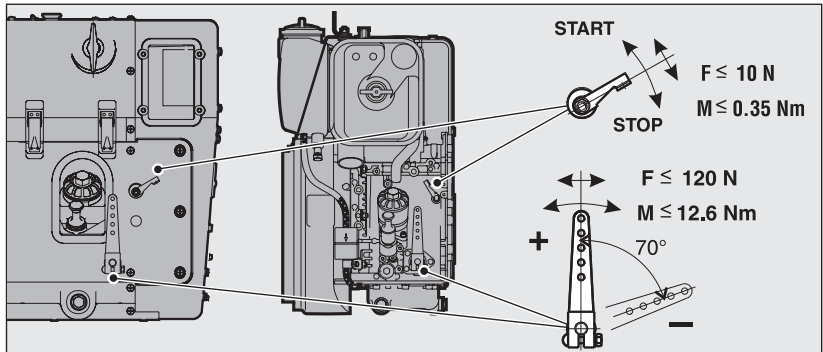

7.2 Performing tests

Before starting

Before starting the engine, several tests need to be performed to ensure the machine is working properly.

Procedure

Step	Test
1	The machine is standing securely and on a level surface.
2	The installation location is adequately ventilated.
3	There is a sufficient amount of fuel in the fuel tank (see chapter 7.7 <i>Refueling</i> , page 58).
4	There is a sufficient amount of engine oil in the engine housing (see chapter 6.4 <i>Filling engine oil (first filling)</i> , page 33).
5	Fill the oil bath air filter (option) with engine oil (see chapter 6.5 <i>Filling the oil bath air filter (option)</i> , page 35).
6	For hand start: <ul style="list-style-type: none"> ▪ Crankhandle in functional condition. ▪ Sliding area between crankhandle and guide sleeve lightly greased.
7	No persons are located in the danger zone of the engine or machine.
8	All safety equipment is in place.

7.3 Start preparation

Procedure

Step	Activity
1	For a hand start, activate automatic decompression (see chapter 7.3.1 <i>Activating automatic decompression</i> , page 38)
2	If necessary, activate the mechanical oil pressure shut down device (for preconditions for activation, see chapter 7.3.2 <i>Activating the mechanical oil pressure shut down device (option)</i> ., page 39)
3	Set the speed adjustment (see chapter 7.3.3 <i>Setting the speed control</i> , page 42).

7.3.1 Activating automatic decompression

Overview – Standard version 1D42, 1D50, 1D81, 1D90 S/Z

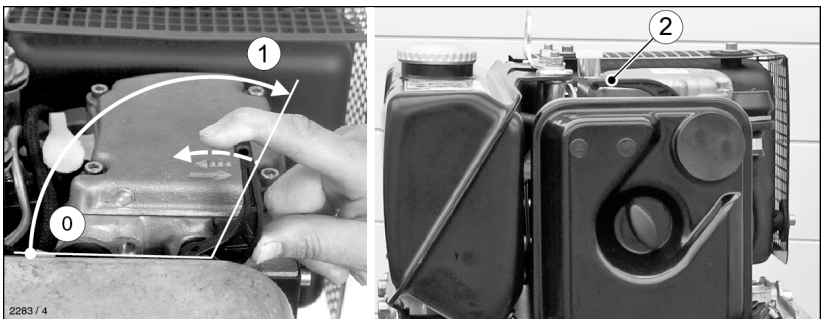

0	Position 0
1	Position 1
2	Decompression lever

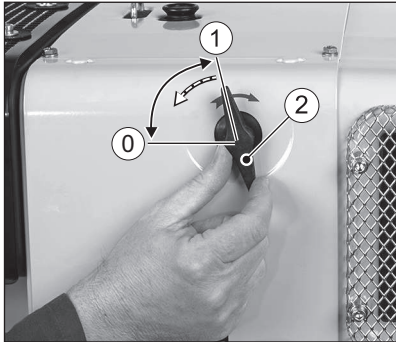
Overview – Encapsulated model 1D81C, 1D90C

0	Position 0
1	Position 1
2	Decompression lever

Procedure

Step	Activity
1	Turn the decompression lever (2) to the end stop (position 1). The automatic decompression engages audibly in this position and the engine is ready to start.

NOTICE

After engaging the automatic decompression on the end stop, five crank handle turns are required until the engine compresses again and can ignite.

7.3.2 Activating the mechanical oil pressure shut down device (option):**Requirements**

Activation of the mechanical oil pressure shut down device is required in the following situations:

- Engine shuts down due to insufficient engine oil supply
- Engine shuts down due to empty fuel tank
- At first filling of the fuel tank
- after turning over at low temperatures
- after several unsuccessful starting processes
- After changing the fuel filter

NOTICE



The mechanical oil pressure shut down device shuts the fuel supply to the injection pump if the oil pressure is too low.

Activation of the mechanical oil pressure shut down device (option) enables the fuel supply again. If the fuel tank is empty or the fuel filter is changed, i.e. when air has gotten into the fuel system, the activation ensures venting of the system.

The fuel tank must be full so that venting is completed after 15 seconds.

Overview – Standard version 1D42, 1D50, 1D81, 1D90 S/Z

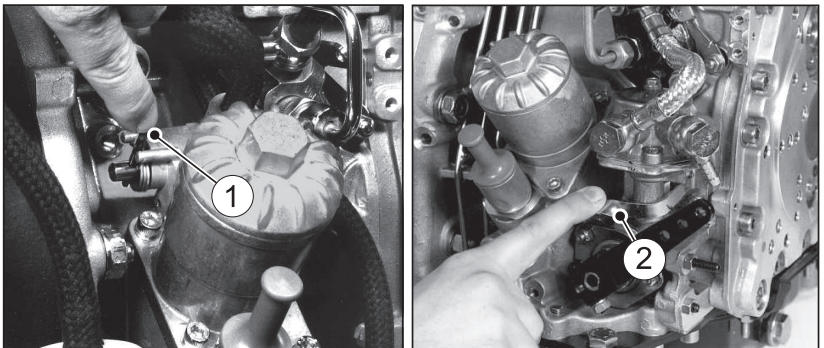

1	Manual lever (oil pressure monitoring)
2	Manual lever (fuel feed pump)

Overview – Encapsulated model 1D81C, 1D90C

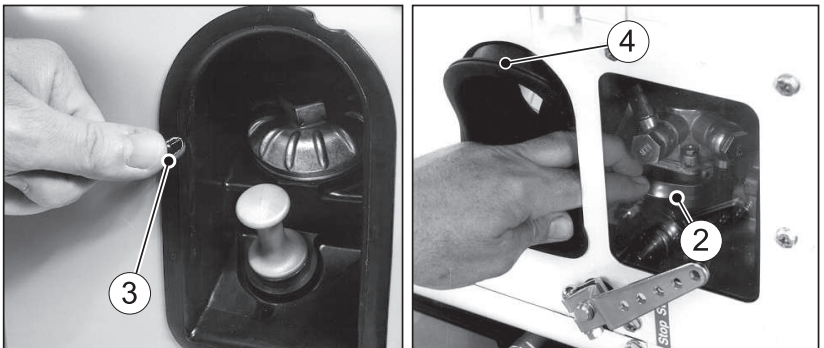

2	Manual lever (fuel feed pump)
3	Pin (oil pressure shut down device)

4	Sleeve
---	--------

Procedure

Step	Activity
1	If the engine has shut down independently, fill with fuel.
2	Check the oil level. Make sure the engine is horizontal when doing this.
3	Top up engine oil if required.
4	<p>Activating the mechanical oil pressure shut down device:</p> <ul style="list-style-type: none"> ▪ Depending on the version, press the manual lever (1) or pin (3) for approx. 15 seconds. <p>For engines with fuel feed pump, pre-pump fuel at the same time:</p> <ul style="list-style-type: none"> ▪ Push the sleeve (4) to the side (encapsulated model only). ▪ Actuate the manual lever (2) on the fuel feed pump several times. <p>After pre-pumping, make sure that the sleeve (4) seals well again.</p>

NOTICE

Despite the mechanical oil pressure shut down device, check the oil level every 8–15 operating hours (see chapter 7.6 *Check the oil level*, page 54).

7.3.3 Setting the speed control

Overview

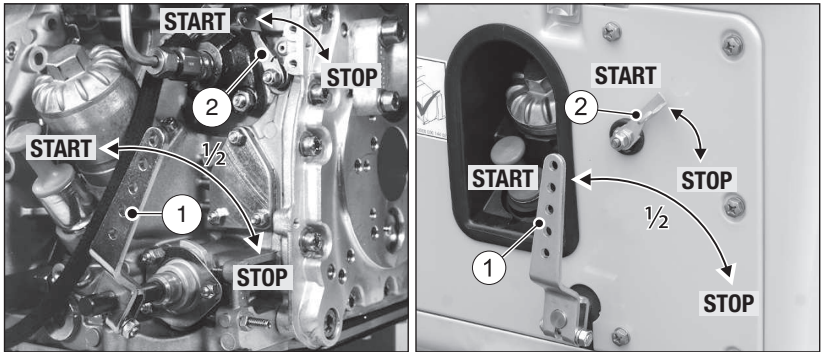

1	Speed control lever
2	Stop lever (option)

Procedure

Step	Activity
1	Depending on the situation, place the speed control lever (1) in either the "1/2" or "Start" position.
2	Ensure that the stop lever (2) is in the "START" operating position. <i>Note:</i> Depending on the equipment, the stop lever can also be operated electrically. See chapter 7.4.3 <i>Starting the engine with a starter</i> , page 48 for further details.

NOTICE	
	<p>A lower speed setting will cause less exhaust smoke when starting.</p>





7.4 Starting the engine

Starting options

A hand start mechanism is standard equipment for the engine. A starter can be installed as an option.









If possible, separate the engine from the machine being driven by uncoupling it. Always switch the machine into idle mode.

Safety notes

 DANGER	
	<p>Danger to life from inhaling exhaust gases.</p> <p>Toxic engine exhaust gases can lead to loss of consciousness, and even death, in closed-off and poorly ventilated rooms.</p> <ul style="list-style-type: none"> ▪ Never operate the machine in closed-off or poorly ventilated rooms. ▪ Do not breathe in the exhaust gases.
 CAUTION	
	<p>Danger of injury and danger of engine damage from the use of starting fluid.</p> <ul style="list-style-type: none"> ▪ Danger of injury during hand starting because the use of starting fluid can result in uncontrolled ignitions. ▪ Engine damage from uncontrolled ignition. ▪ Never use starting fluid.
NOTICE	
	<p>When the engine is running, a vacuum occurs in the intake opening for combustion air. Position of the intake opening, see chap. 5.1 <i>Designation of components</i>, page 27.</p> <ul style="list-style-type: none"> ▪ Keep parts of the body and hair away from the intake opening.

7.4.1 Starting the engine with crankhandle

Safety notes

 CAUTION	
	<p>Danger of injury when starting with a crank handle.</p> <p>Starting with the crank handle requires a greater amount of force.</p> <ul style="list-style-type: none"> ▪ The crank handle may not be operated by children or by people with a less powerful build. ▪ Perform the starting procedure exactly according to the instructions.
 CAUTION	
	<p>Danger of injury from defective crank handle.</p> <p>A damaged or broken handle bar can cause injuries. A worn drive dog can slip out of the starting mechanism when starting and also cause injuries.</p> <ul style="list-style-type: none"> ▪ Check the crank handle for a broken handle bar, worn drive dog etc.; replace if necessary.
 CAUTION	
	<p>Danger of injury from recoiling of the engine.</p> <ul style="list-style-type: none"> ▪ Use a crank handle with a recoil damper. ▪ Hold the handle bar so that it cannot twist and quickly turn the crank so that continuous traction between the engine and crank is ensured. ▪ If recoil occurs due to cautious turning where the engine starts in the opposite sense of rotation under certain circumstances (smoke from the air filter), release the crank handle immediately and stop the engine. ▪ To repeat the starting process, wait until the engine has stopped; only then recommence start preparations.
 CAUTION	
	<p>Danger of injury if the crankhandle recoils or turns with the engine.</p> <ul style="list-style-type: none"> ▪ The use of crankhandles without recoil damping is not permissible within the European Union.

Overview

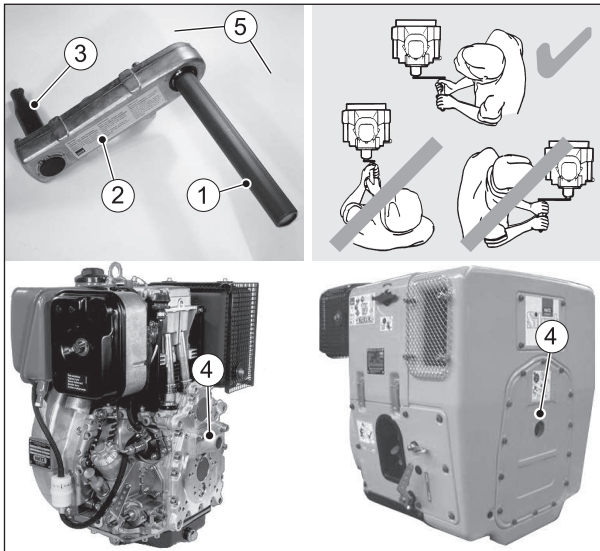

1	Handle bar
2	Crank arm
3	Drive dog
4	Guide sleeve
5	Crankhandle

Starting the engine with a crankhandle with kick-back damping

Step	Activity
1	Carry out start preparations (see chapter 7.3 <i>Start preparation</i> , page 38).
2	Insert the drive dog into the guide sleeve.
3	Assume the correct position.
4	Grasp the handle bar with both hands.
5	First turn the crank handle slowly until the drive dog and the engagement mechanism of the crank handle engage.
6	Turn the crank handle forcefully with increasing speed. When the decompression lever engages in the "0" position (compression), the highest possible speed must be reached.
7	As soon as the engine starts, pull the crank handle out of the guide sleeve.

NOTICE

If recoil occurs during the starting process, the crank arm/drive dog linkage releases via the handle bar due to the short reverse rotation.

Starting the engine with a crank handle without recoil damping**CAUTION****Danger of injury from recoiling of the engine.**

- If recoil occurs due to cautious turning where the engine starts in the opposite sense of rotation under certain circumstances (smoke from the air filter), release the crankhandle immediately and stop the engine.
 - **Danger from turning crankhandle!**
- To repeat the starting process, wait until the engine has stopped; only then recommence start preparations.

Step	Activity
1	Carry out start preparations (see chapter 7.3 <i>Start preparation</i> , page 38).
2	Insert the drive dog into the guide sleeve.
3	Assume the correct position.
4	Grasp the handle bar (1) with both hands.
5	Slowly turn the crank handle until the drive dog (3) engages.
6	Turn the crank handle forcefully with increasing speed. When the decompression lever engages in the "0" position (compression), the highest possible speed must be reached.
7	As soon as the engine starts, pull the crank handle out of the guide sleeve (4).

7.4.2 Starting the engine when cold

Overview

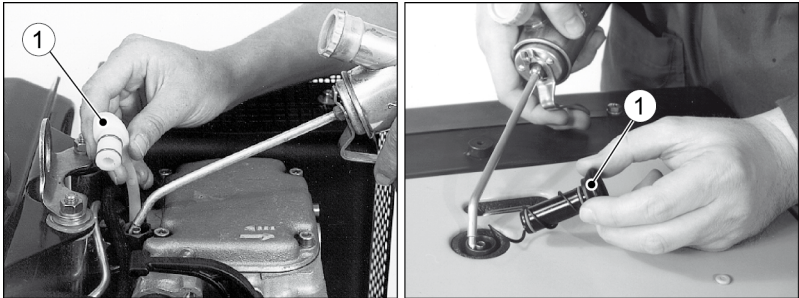

- | | |
|---|------------------------|
| 1 | Cover with dosing unit |
|---|------------------------|

NOTICE



Idle the engine thoroughly at temperatures below approx. -5°C .

Procedure

Step	Activity
1	Move the decompression lever to the middle position (see chapter 7.3.1 <i>Activating automatic decompression</i> , page 38).
2	Turn the engine with the crank handle until it noticeably turns easier (10 – 20 crank revolutions).
3	If equipped with a mechanical oil pressure shut down device, press the manual lever or pin for approx. 15 seconds (see chapter 7.3.2 <i>Activating the mechanical oil pressure shut down device (option)</i>);, page 39).
4	Remove dirt in the area of the dosing unit cover (1) and pull off the cover.
5	Fill low viscosity engine oil up to the upper edge in the casing.
6	Mount the dosing unit cover (1) and press firmly into place. Two consecutive fillings are required.
7	Pull the decompression lever to the end stop.
8	Start the engine immediately (see chapter 7.4.1 <i>Starting the engine with crankhandle</i> , page 44).

7.4.3 Starting the engine with a starter

Overview – HATZ instrument boxes

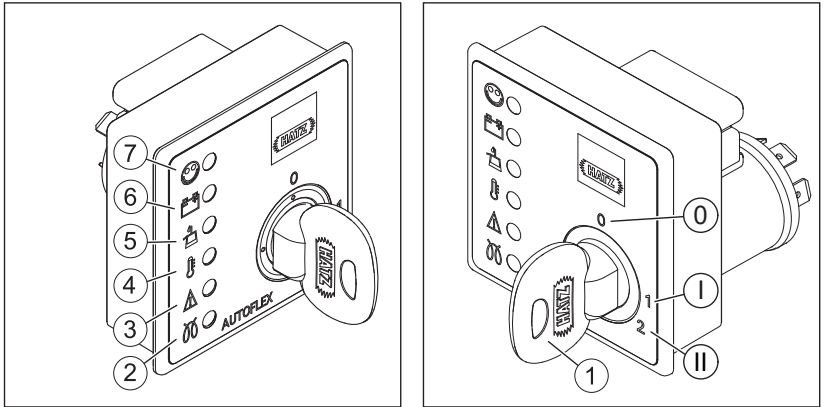







1	Starting key
2	Pre-glow indicator (option)
3	Indicator for special customer functions (see the section "Explanation of symbols")
4	Engine temperature display (option)
5	Oil pressure indicator
6	Charge control
7	Operating indicator
Ignition lock	
0	Off
I	Operation
II	Start

Indicator lamps

The function of all indicators is checked after the starting key is turned to position "I". They light up consecutively from top to bottom. After the test, only the indicators for charge control and oil pressure are lit. If there is a fault, the applicable indicator does not go out after the engine start or it lights up again during operation. If the unit is switched off due to overspeed, all LEDs flash.

Explanation of symbols

Symbol	Meaning
	Operating indicator Lights up during operation when there is no engine fault.
	Charge control Fault in the alternator or alternator charging circuit. The battery is no longer charged. Eliminate the fault immediately.
	Oil pressure indicator Engine oil pressure too low. Danger of engine damage. Stop the engine immediately and check the oil level (see chapter 7.6 <i>Check the oil level, page 54</i>). Contact the HATZ service if the oil level is correct.
	Engine temperature display Engine temperature is impermissibly high. Danger of engine damage. Switch off the engine immediately! For details of troubleshooting, see chapter 9.1 <i>Troubleshooting, page 91</i> .
	Special customer functions (e.g., electrical maintenance switch or stop switch). For further information, see the documentation for the complete machine.
	Pre-glow indicator Lights up at temperatures below 0 °C (depending on the setup). Start the engine after the indicator has gone out.

Overview – Electrical operation of the stop lever (option)

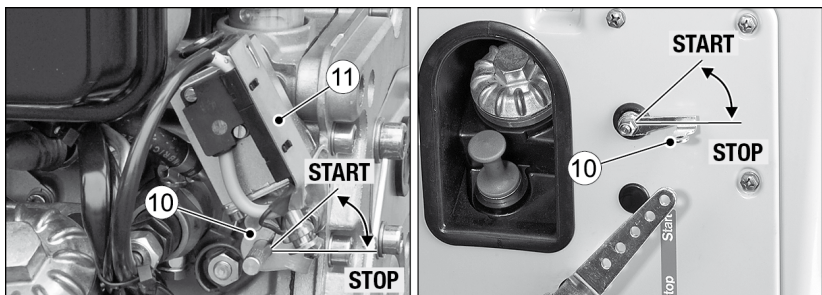

10	Stop lever
11	Stop magnet

Functional description

The stop lever (10) is actuated with the stop magnet (11). At starting key position (0) the stop lever is in the "STOP" position - the engine can not be started.

When the starting key is turned into position (I) the stop magnet sets the stop lever to the "START" operating position - the engine is ready to start.

Procedure – Starting the engine with a starter

NOTICE	
	<ul style="list-style-type: none"> ▪ Start for max. 30 seconds. If the engine is still not running after that, turn the starting key back to position "0" and eliminate the cause (see chapter 9.1 <i>Troubleshooting</i>, page 91). ▪ Turn the starting key to position "0" every time you want to start the engine. ▪ The anti repeat device in the ignition lock makes it impossible for the starter to engage while the engine is running and become damaged.

Step	Activity
1	Check the speed control (see chapter 7.3.3 <i>Setting the speed control</i> , page 42).
2	Insert the starting key all the way and turn to position "I". When the pre-glow indicator (2) lights up, wait until it goes out and then continue with step 3.
3	Turn the starting key to position "II".
4	As soon as the engine is running, release the starting key. <ul style="list-style-type: none"> ▪ The starting key springs back to position "I" and remains in this position during operation. ▪ The charge control (6) and oil pressure indicator (5) go out. ▪ The operating indicator (7) lights up and signals there is no engine fault.

NOTICE	
	<ul style="list-style-type: none"> ▪ In case of irregularities, switch off the engine immediately. ▪ Identify the fault and eliminate it. ▪ For details of troubleshooting, see chapter 9.1 <i>Troubleshooting</i>, page 91.

NOTICE

If the engine does not start within the time defined in the setup after the instrument box is switched on, the instrument box is put in Sleep mode to minimize electrical power consumption. The green LED for the operating display indicates that Sleep mode is active by flashing at intervals of 10 s. The instrument box is made operational again by turning the starting key to position "0" and then back to "1".

Automatic electrical shutoff (option)**NOTICE**

- If the engine stops again immediately after starting, or stops independently during operation, this is an indication that a monitoring element of the automatic shutoff has activated.
- Remedy the fault before making further starting attempts (see chapter 9.1 *Troubleshooting*, page 91).
- The automatic shutoff is **no** protection against low oil level. This means that the oil level must be checked every 8 - 15 operating hours despite the automatic shutoff. (see section 7.6 *Check the oil level*, page 54).

Procedure when faults occur

Step	Activity
1	Check the indicators. After the engine stops, the fault is indicated by the appropriate indicator.
2	Remedy the fault before making further starting attempts (see chapter 9.1 <i>Troubleshooting</i> , page 91). The indicator then goes out at the next start.

7.5 Switching off the engine**Safety notes****CAUTION****Danger of injury from unauthorized access.**

There is a danger of injury if unauthorized persons handle the machine.

- Protect the crankhandle and starting key against unauthorized access upon breaks in operation or after completing work.

CAUTION	
	<p>Danger of engine damage.</p> <ul style="list-style-type: none"> Never stop the engine on the decompression lever.

Methods of switching off the engine

The engine can be switched off in different ways depending on how it is equipped:

- Speed control lever (mechanical)
- Stop lever (mechanical)
- Starting key (electrical)

7.5.1 Switching off the engine (mechanical)

NOTICE	
	<p>Engines with a blocked lower idle speed cannot be switched off with the speed control lever. In this case, the engine is switched off with the stop lever or starting key, depending on how the engine is equipped.</p>

Overview

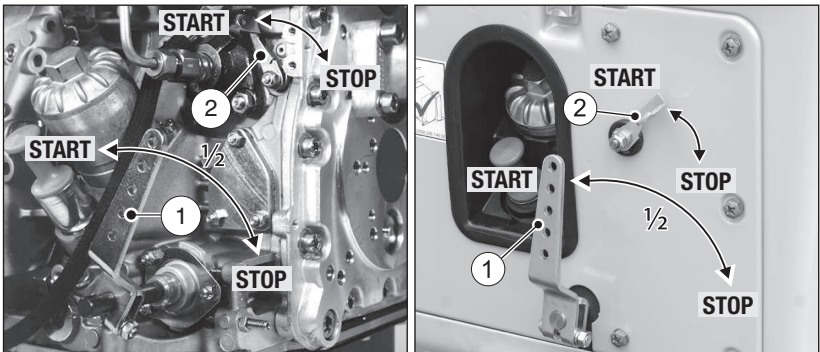

1	Speed control lever
2	Stop lever (option)

Procedure

Step	Activity
Speed control lever	
1	Push the speed control lever (1) all the way to the "STOP" position. The engine switches off.
Stop lever	

Step	Activity
1	Actuate the stop lever (2) in the "STOP" direction and hold until the engine has stopped.
2	Release the stop lever (2). The stop lever is placed automatically in the "START" position by a spring.

NOTICE

Engines with a stop magnet can not be switched off by actuating the stop lever, rather only with the starting key (see chapter 7.5.2 *Switching off the engine (electrical)*, page 53).

NOTICE

After it is switched off, the engine continues running for a few seconds. Before performing any further activities, wait until all moving components have come to a complete standstill.

7.5.2 Switching off the engine (electrical)

Overview

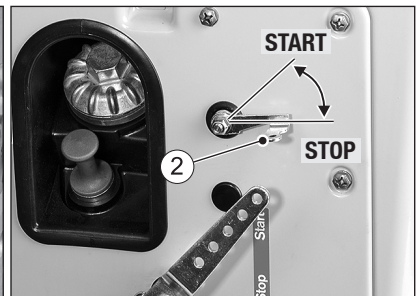
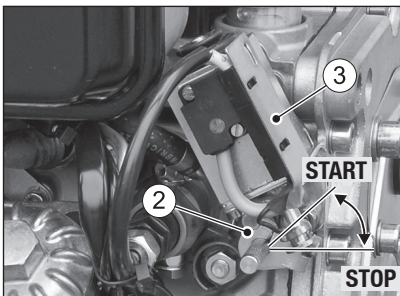
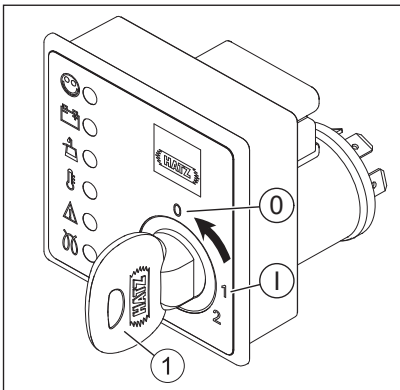

1	Starting key
2	Stop lever
3	Stop magnet
Ignition lock	
0	Off
I	Operation

Procedure

Step	Activity
1	<p>Turn the starting key to position "0".</p> <p>The stop lever (2) is actuated in the "STOP" position with the stop magnet (3).</p> <p>The engine switches off.</p> <p>All indicator lamps go out.</p> <p><i>Note:</i> The engine continues running for several seconds after it is switched off. Before performing any further activities, wait until all moving components have come to a complete standstill.</p>
2	Remove the starting key.

NOTICE





Danger of exhaustive battery discharge.

- When the machine is switched off, always turn the starting key to position "0" or else the battery may become fully discharged.

7.6 Check the oil level

Safety notes

 CAUTION	
 	<p>Danger of burns.</p> <p>There is a danger of burns when working on a hot engine.</p> <ul style="list-style-type: none"> Wear safety gloves.

**CAUTION****Danger of injury**

Prolonged contact with engine oil can lead to irritation of the skin.



- Wear safety gloves.
- If there is contact with the skin, thoroughly wash the affected areas of the skin with soap and water.

CAUTION**Danger of later engine damage.**

- Operating the engine with an oil level below the **min.** mark or above the **max.** mark can lead to engine damage.
- When checking the oil level, the engine must be horizontal and have been switched off for a few minutes.

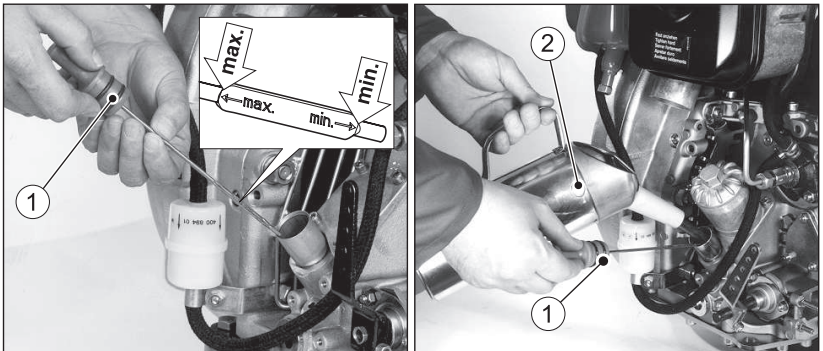
7.6.1 Engine oil level**Overview – Standard version 1D42, 1D50, 1D81, 1D90 S/Z**

1	Dipstick
2	Oil refilling container

Overview – Encapsulated model 1D81C, 1D90C

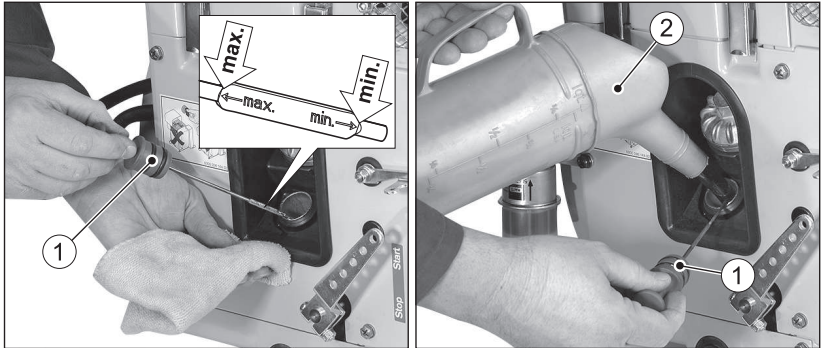

1	Dipstick
2	Oil refilling container

Procedure — Checking oil level/adding oil

Step	Activity
1	Switch off the engine and wait several minutes for the engine oil to collect in the crankcase. Engine must be level.
2	Remove contamination on the engine in the area of the dipstick (1).
3	Pull out the dipstick and wipe it off with a clean towel.
4	Reinsert the dipstick.
5	Pull out the dipstick and check the oil level.
6	If the oil level is close to the min. mark, add engine oil to the max. mark. For the specification and viscosity, see chapter 4.4 <i>Engine oil</i> , page 25.
7	Reinsert the dipstick.

7.6.2 Oil level in the oil bath air filter (option)

Overview

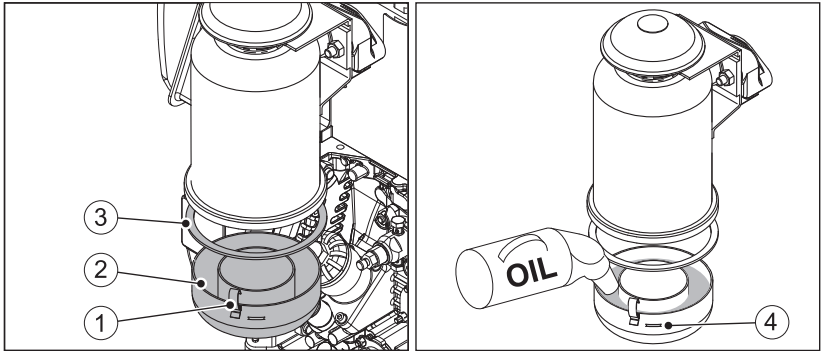









1	Clamp fastener (2x opposing)
2	Oil container
3	Seal ring
4	Level mark

Procedure

Step	Activity
1	Release the clamp fasteners (1).
2	Remove the oil container (2).
3	Check for dirt. When the deposited dirt has reached approximately half the height of the oil filling or the oil has become viscous, clean the oil bath air filter (see chapter 8.2.6 <i>Cleaning the oil bath air filter (option)</i> , page 76).
4	Otherwise check the oil level and fill with engine oil up to the level mark (4) as required.
5	Mount the oil container, ensuring that the gasket (3) is properly positioned and the clamp fasteners (1) are correctly fastened.

7.7 Refueling

Safety notes

 DANGER	
 	<p>Fire hazard from fuel.</p> <p>Leaked or spilled fuel can ignite on hot engine parts and cause serious burn injuries.</p> <ul style="list-style-type: none"> ▪ Only refuel when the engine is switched off and has cooled down. ▪ Never refuel in the vicinity of open flames or sparks that can cause ignition. ▪ Do not smoke. ▪ Do not spill fuel.
 CAUTION	
	<p>Danger of environmental damage from spilled fuel.</p> <p>Do not overfill the fuel tank and do not spill fuel.</p> <ul style="list-style-type: none"> ▪ Collect any leaking fuel and dispose of it according to local environmental regulations.
 CAUTION	
 	<p>Danger of injury.</p> <p>Repeated contact with diesel fuel can cause chapped and cracked skin.</p> <ul style="list-style-type: none"> ▪ Wear safety gloves. ▪ If there is contact with the skin, thoroughly wash the affected areas of the skin with soap and water.
CAUTION	
	<p>Engine damage from using low quality fuel.</p> <p>The use of fuel that does not meet the specifications can lead to engine damage.</p> <ul style="list-style-type: none"> ▪ Only use the fuel specified in chapter 4.5 <i>Fuel</i>, page 26. ▪ The use of fuels that do not meet specifications require approval by Motorenfabrik HATZ (main plant).

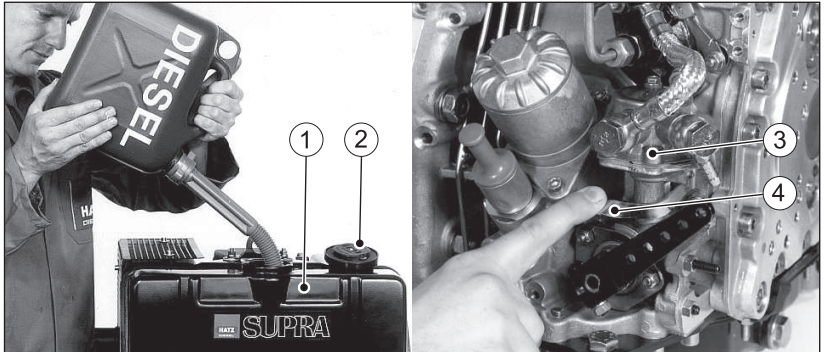
Overview – Standard version 1D42, 1D50, 1D81, 1D90 S/Z

1	Fuel tank
2	Fuel cap
3	Fuel feed pump
4	Manual lever

Procedure**NOTICE**

- Before starting for the first time or if the fuel system is empty, fill the fuel tank fully with diesel fuel.
- The fuel system is bled automatically if the fuel tank is attached to the engine or located higher than the injection pump.
- If the fuel tank is not built on and lying lower, it must be pre-pumped with the manual lever of the fuel feed pump.
- The mechanical oil pressure shut down device (option) must be activated before filling for the first time or if the fuel tank is empty.

Step	Activity
1	Open the fuel cap.
2	Fill the fuel tank with diesel fuel.
3	Close the fuel cap.
4	Proceed as follows if the fuel system is empty and the fuel tank is lower lying: <ul style="list-style-type: none"> ▪ Pre-pump with the manual lever (4) on the fuel feed pump (3) until the fuel audibly flows back through the return line into the fuel tank.



Step	Activity
5	If necessary, activate the mechanical oil pressure shut down device (option) (see chapter 7.3.2 <i>Activating the mechanical oil pressure shut down device (option)</i> ; page 39).

Encapsulated model 1D81C, 1D90C

Encapsulated models of engines in do not have their own fuel tank. Follow the instructions from the equipment manufacturer as well as the safety instructions in this chapter.

7.8 Checking the water separator

Safety notes

 CAUTION	
	<p>Danger of environmental damage from spilled fuel.</p> <p>When water is drained from the water separator, a small amount of fuel is drained as well.</p> <ul style="list-style-type: none"> Collect any escaped water/fuel mixture and dispose of it according to local environmental regulations.
NOTICE	
	<p>The interval for checking the water separator depends entirely on the proportion of water in the fuel and on the care exercised during refueling; the water separator should be checked at least once a week.</p>

Overview – Standard version 1D42, 1D50, 1D81, 1D90 S/Z

Water in the fuel tank collects at the lowest point of the fuel tank in the water separator.

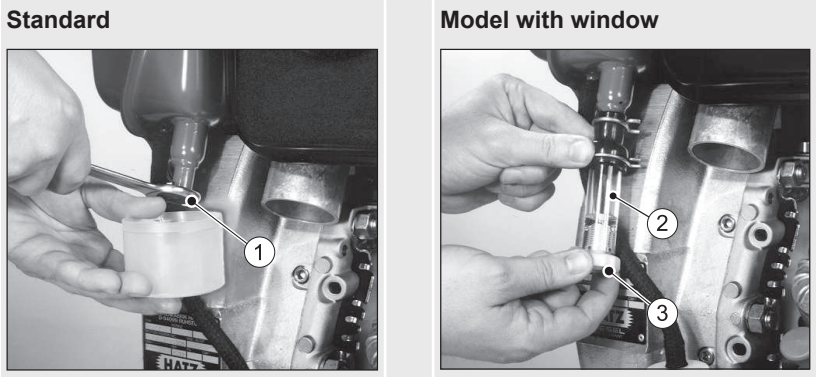

1	Drain screw, hex (standard)
2	Window (additional equipment)
3	Drain screw (manually operated)

Procedure

Step	Activity
1	Model with window: Check the window (2) for water content. Collected water can be clearly identified by the noticeable separating line between the water and the diesel fuel above it.
2	Place a suitable container under the drain screw (1) or (3). <i>NOTE:</i> In inaccessible locations, an extension hose can be mounted on the drain screw (3).
3	Open the drain screw (1) or (3) and drain the water into the container.
4	When fuel emerges, close the drain screw.
5	Dispose of the water/fuel mixture in accordance with the local environmental regulations.

Encapsulated model 1D81C, 1D90C

Encapsulated models of engines do not have their own fuel tank. Follow the instructions from the equipment manufacturer as well as the safety instructions in this chapter.

7.9 Check the air filter warning indicator (option)

Overview

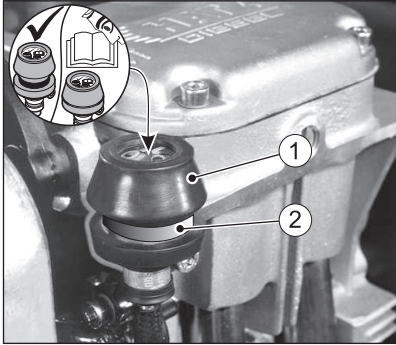

1	Rubber bellow
2	Green field



Procedure

Step	Activity
1	Bring the engine briefly to maximum speed.
2	When the rubber bellow (1) contracts and covers over the green field (2), immediately check the air filter system (see chapter 8.2.11 <i>Maintaining the dry air filter</i> , page 87).
3	Check the rubber bellow (1) several times daily under dusty conditions.

8 Maintenance

8.1 General maintenance instructions

Safety notes

 WARNING	
	<p>Danger of injury from failure to follow the Operating Instructions and from performing unauthorized tasks on the machine.</p> <ul style="list-style-type: none"> ▪ Follow all instructions. ▪ Do not perform activities for which no qualification is available. Contact properly trained personnel if necessary.

NOTICE	
	<p>Comply with the safety chapter!</p> <p>Follow the basic safety instructions in chapter 3 <i>Safety</i>, page 7.</p>

- Maintenance tasks may only be performed by trained personnel.
- Accident prevention measures must be in accordance with the local accident prevention regulations.
- Perform setting and maintenance work at the specified intervals.
- Replace defective machine parts as soon as possible.
- Always wear personal protection equipment.
- Only use fully functional tools.
- Installation of unsuitable spare parts can lead to problems. We cannot accept liability for direct damage or secondary damage that results from this. We therefore recommend the use of **Hatz original spare parts**.
- Closely adhere to the maintenance conditions prescribed in this manual.
- Only make changes to the machine in agreement with the manufacturer.
- Only perform maintenance work when the engine is switched off.
- Protect start-up devices (crank handle, recoil start or starting key) from unauthorized access.
- For engines with an electric starter: Disconnect the negative battery terminal before carrying out maintenance work.
- Adhere to legal regulations when handling and disposing of used oil, filters, and cleaning agents.
- After completing maintenance work, check that all tools, screws, aids, and other objects are removed from the machine, and that all safety equipment has been replaced.

- Before starting, ensure that no persons are located in the danger zone of the engine or machine.



Performance of maintenance work

The entire machine is designed to be maintenance friendly. Parts that require maintenance are easily accessible.

- Perform maintenance work faithfully at the specified intervals to prevent premature wear of the machine.
- Follow the notice and warning labels on the machine.
- Always retighten screw connections loosened during maintenance work.
- After the necessary maintenance and repair work is completed, perform a function test (test run).
- For maintenance work that is not listed and described in the maintenance documentation, please contact your nearest **HATZ service station**.

8.2 Maintenance work

Safety note

 CAUTION	
	<p>Danger of injury from ignoring the maintenance instructions.</p> <ul style="list-style-type: none">▪ Only perform maintenance work when the engine is switched off.▪ Protect start-up devices (crank handle, recoil start or starting key) from unauthorized access.▪ For engines with a starter: Disconnect the negative battery terminal.▪ When the maintenance work has been completed, ensure that all tools are removed from the machine.

8.2.1 Maintenance notice label

NOTICE



The following illustrated maintenance label is delivered with every engine.

- It should be mounted on the engine or machine in a clearly visible location.
- The maintenance intervals specified on the maintenance plan must be adhered to (see chapter 8.2.2 *Maintenance plan*, page 66)

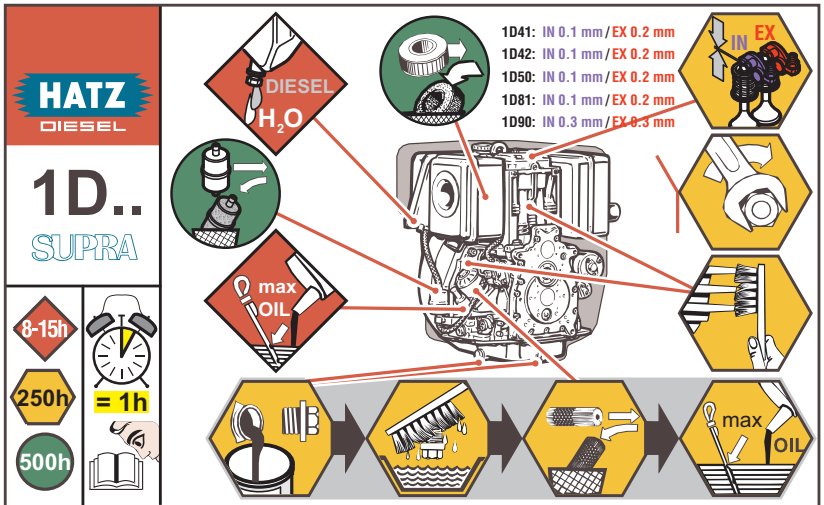

8.2.2 Maintenance plan

NOTICE



The maintenance intervals listed below apply to standard applications. If the operating conditions differ significantly from the usual use cases, it is possible that Hatz and the manufacturer of the complete machine reached a special agreement stipulating shorter or longer maintenance intervals. Corresponding information regarding different maintenance intervals can be found in the documentation of the complete machine.



Daily checks

Symbol	Interval	Activity/check	Chapter
	Every 8–15 operating hours or every day before starting	Check the oil level	7.6 <i>Check the oil level, page 54</i>
		Check the air filter maintenance indicator	7.9 <i>Check the air filter warning indicator (option), page 62</i>
		Check the intake area of the combustion air	8.2.3 <i>Checking the intake area of the combustion air, page 67</i>
		Checking the cooling air area	8.2.4 <i>Checking the cooling air area, page 69</i>
		Check the engine oil level is correct in the bottom section of the oil bath air filter and examine the oil for contamination.	7.6.2 <i>Oil level in the oil bath air filter (option), page 57</i>

Initial maintenance of new or rebuilt engines

Symbol	Maintenance interval	Maintenance step/check	Chapter
	After the first 25 operating hours	Change the engine oil ¹⁾	8.2.5 <i>Changing the engine oil and oil filter, page 71</i>
		Check and set the tappet clearance	8.2.7 <i>Checking and setting the tappet clearance, page 79</i>
		Check the screw connections	8.2.9 <i>Check the screw connections, page 83</i>

Routine maintenance



Symbol	Maintenance interval	Maintenance step/check	Chapter
	Weekly	Checking the water separator	7.8 <i>Checking the water separator, page 60</i>
	Every 250 operating hours	Change the engine oil ¹⁾	8.2.5 <i>Changing the engine oil and oil filter, page 71</i>
		Clean the oil bath air filter ¹⁾	8.2.6 <i>Cleaning the oil bath air filter (option), page 76</i>
		Check and set the tappet clearance ¹⁾	8.2.7 <i>Checking and setting the tappet clearance, page 79</i>
		Clean the cooling air area ¹⁾	8.2.8 <i>Cleaning the cooling air area, page 82</i>
		Check the screw connections ¹⁾	8.2.9 <i>Check the screw connections, page 83</i>
	Every 500 operating hours	Change the fuel filter ^{1) 2)}	8.2.10 <i>Changing the fuel filter, page 84</i>
		Change the air filter cartridge ¹⁾	8.2.11 <i>Maintaining the dry air filter, page 87</i>

¹⁾ Maintenance according to the maintenance interval or after 12 months, whichever comes first.

²⁾ The interval at which maintenance work should be performed on the fuel filter depends on the cleanliness of the fuel in use and may need to be shortened to 250 operating hours.

8.2.3 Checking the intake area of the combustion air

Safety notes

 CAUTION	
 	<p>Danger of burns.</p> <p>There is a danger of burns when working on a hot engine.</p> <ul style="list-style-type: none"> ▪ Let the engine cool. ▪ Wear safety gloves.

NOTICE

In case of heavy contamination, shorten the maintenance intervals accordingly (see chapter 8.2.2 *Maintenance plan*, page 66).

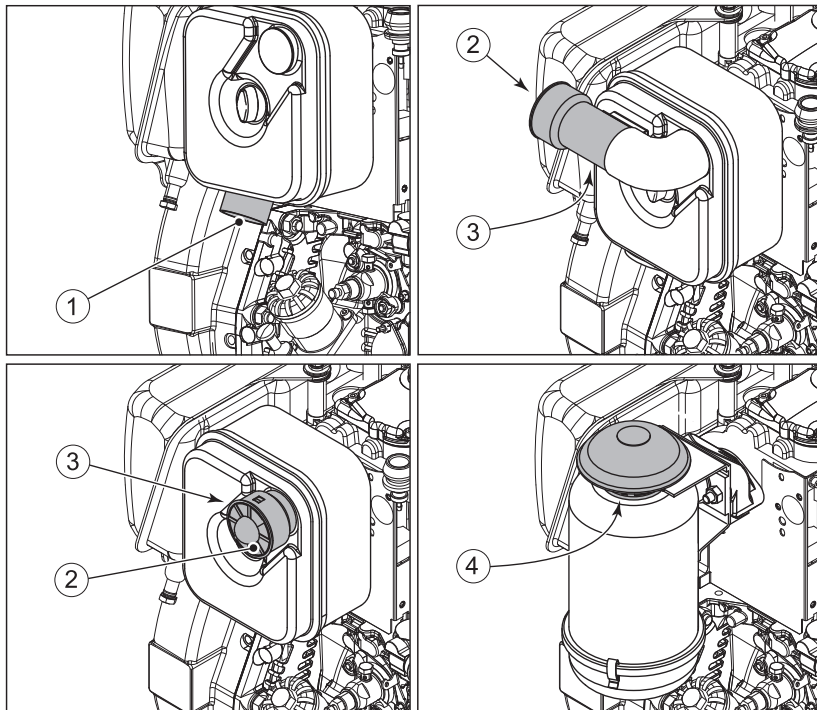
Overview – Standard version 1D42, 1D50, 1D81, 1D90 S/Z

1	Intake opening on the dry air filter
2	Intake opening on the cyclone precleaner (option)
3	Dust outlet opening on the cyclone precleaner
4	Intake opening on the oil bath air filter (option)

Overview – Encapsulated model 1D81C, 1D90C

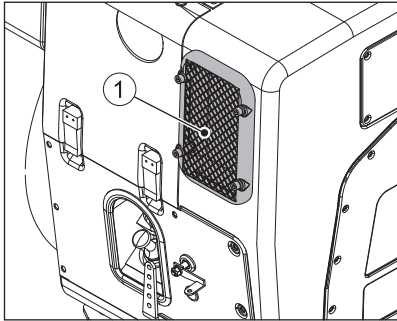



1 Intake opening for combustion air and cooling air

Procedure

Step	Activity
1	<p>Depending on the model, check the intake opening (1, 2 or 4) for coarse contamination such as leaves, heavy dust deposits, etc.</p> <p>Perform the following activities in case of heavy contamination:</p> <ul style="list-style-type: none"> ▪ Chapter 8.2.11 <i>Maintaining the dry air filter</i>, page 87
2	<p>In models with a cyclone precleaner, also check the dust outlet opening (3) is clear, and clean as required in addition to step 1.</p>

8.2.4 Checking the cooling air area

Safety notes

 CAUTION	
	<p>Danger of burns.</p> <p>There is a danger of burns when working on a hot engine.</p> <ul style="list-style-type: none"> ▪ Let the engine cool before maintenance.
CAUTION	
	<p>Danger of engine damage from overheating.</p> <p>The engine temperature display (option) lights up as soon as the engine becomes impermissibly hot.</p> <ul style="list-style-type: none"> ▪ Switch off the engine immediately and eliminate the cause.

NOTICE

In case of heavy contamination, shorten the maintenance intervals accordingly (see chapter 8.2.2 *Maintenance plan*, page 66).

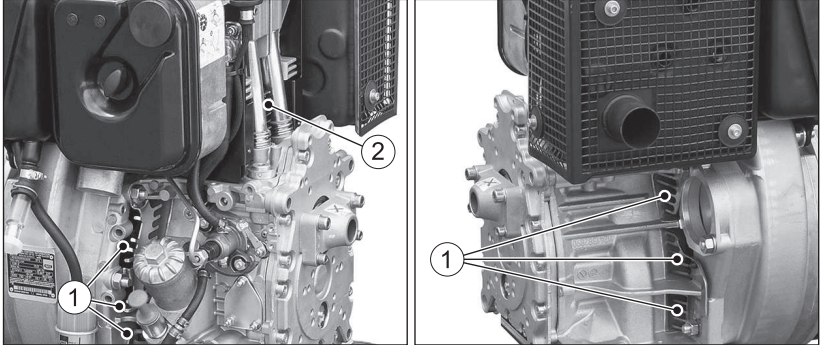
Overview – Standard version 1D42, 1D50, 1D81, 1D90 S/Z

- | | |
|---|--------------------------------|
| 1 | Intake opening for cooling air |
| 2 | Coolant air outlet |









Overview – Encapsulated model 1D81C, 1D90C

- | | |
|---|---|
| 1 | Intake opening for combustion air and cooling air |
| 2 | Coolant air outlet |

Procedure

Step	Activity
1	Depending on the model, check the intake opening (1) and cooling air outlet (2) for coarse contamination such as leaves, heavy dust deposits, etc., and clean if necessary (see chapter 8.2.8 <i>Cleaning the cooling air area, page 82</i>).

8.2.5 Changing the engine oil and oil filter**Safety notes**

 CAUTION	
 	<p>Danger of burns.</p> <p>When working on the engine, there is a danger of burns from hot oil.</p> <ul style="list-style-type: none"> ▪ Wear personal protective equipment (gloves).
 CAUTION	
	<p>Danger of environmental damage from spilled used oil.</p> <p>Used oil is water-polluting.</p> <ul style="list-style-type: none"> ▪ Do not allow them to enter the ground water, water bodies, or sewage system. ▪ Collect the used oil and dispose of it according to local environmental regulations.
 CAUTION	
 	<p>Danger of injury</p> <p>Prolonged contact with engine oil can lead to irritation of the skin.</p> <ul style="list-style-type: none"> ▪ Wear safety gloves. ▪ If there is contact with the skin, thoroughly wash the affected areas of the skin with soap and water.

CAUTION
**Danger of injury.**

When working with compressed air, foreign bodies may fly into your eyes.



- Wear safety goggles.
- Never direct the compressed air jet toward people or toward yourself.

CAUTION**Danger of later engine damage.**

- Operating the engine with an oil level below the **min.** mark or above the **max.** mark can lead to engine damage.
- When checking the oil level, the engine must be horizontal and have been switched off for a few minutes.

NOTICE

- The engine must be level.
- The engine must be switched off.
- Only drain engine oil while it is warm.

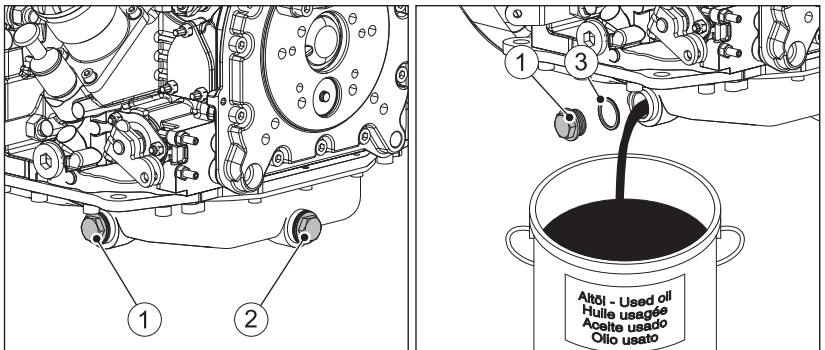
Draining the engine oil**Overview – Standard version 1D42, 1D50, 1D81, 1D90 S/Z**

1	Oil drain screw (side)
2	Oil drain screw (front)
3	Seal ring

Procedure

Step	Activity
1	Keep a container ready for collecting the used oil. The container must be large enough to hold the entire amount of engine oil. For the engine oil capacity, see chapter 4.1 <i>Engine information and filling quantities</i> , page 22.
2	Depending on accessibility, the engine oil can be drained at oil drain screw (1) or (2). Unscrew the oil drain screw and drain the used oil entirely.
3	Screw in the cleaned oil drain screw with the new sealing ring and tighten. Tightening torque: 50 Nm.

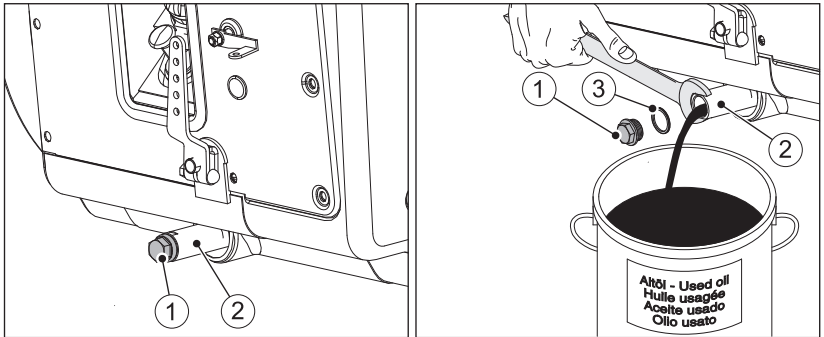
Overview – Encapsulated model 1D81C, 1D90C

1	Oil drain screw
2	Drain pipe
3	Gasket

Procedure

Step	Activity
1	Unscrew the oil drain screw (1). Ensure that the drain pipe (2) is not loosened. Hold it with an open-end wrench. Entirely drain the used oil.
2	Screw in the cleaned oil drain screw with the new gasket (3) and tighten.

Changing the oil filter (option)

Overview

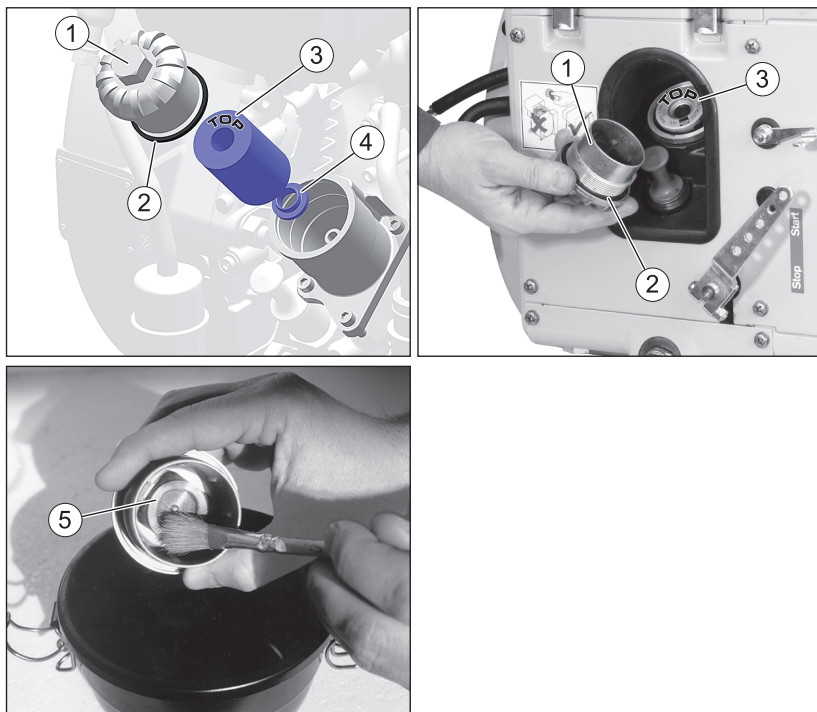

1	Screw plug for oil filter
2	Sealing ring for screw plug
3	TOP marking on the oil filter
4	Sealing ring on oil filter
5	Screen insert

Procedure

Step	Activity
1	Unscrew the screw cap (1).
2	Clean the screen insert (5) carefully to ensure that the wire mesh is not bent. Wipe out the screw cap or blow it out with compressed air.

Step	Activity
3	Pull out the old oil filter and dispose of it in accordance with local environmental regulations. When pulling out the oil filter, the sealing ring (4) may remain in the housing. Remove the sealing ring (4) from the housing as well.
4	When inserting the new oil filter, pay attention to the "TOP" marking (3).
5	Renew the gasket ring (2).
6	Coat the screw cap thread and gasket with "K" lubricant, see spare parts list.
7	Screw in and tighten the screw cap.

Filling the engine oil

Overview – Standard version 1D42, 1D50, 1D81, 1D90 S/Z

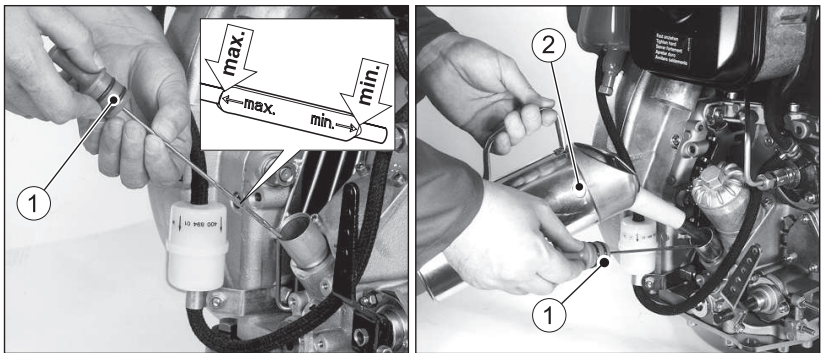

1	Dipstick
2	Oil refilling container

Overview – Encapsulated model 1D81C, 1D90C

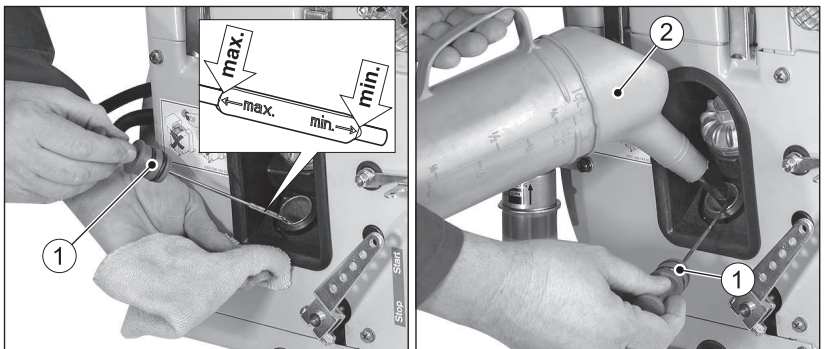





1	Dipstick
2	Oil refilling container

Procedure

Step	Activity
1	Pull out the dipstick (1) and clean it.
2	Fill engine oil. For the specification and viscosity, see chapter 4.4 <i>Engine oil, page 25</i> . For the filling quantity, see chapter 4.1 <i>Engine information and filling quantities, page 22</i> .
3	Reinsert the dipstick.
4	Pull out the dipstick and check the oil level.
5	If required, add engine oil to the max. mark.
6	Reinsert the dipstick.
7	Check the oil level again after a short test run and top up engine oil as required.
8	Check the oil drain screw and screw cap on the oil filter for leaks.

8.2.6 Cleaning the oil bath air filter (option)

Safety notes

 CAUTION	
	<p>Danger of burns.</p> <p>There is a danger of burns when working on a hot engine.</p> <ul style="list-style-type: none"> Let the engine cool before maintenance.
 CAUTION	
	<p>Danger of environmental damage from spilled used oil.</p> <p>Used oil is water-polluting.</p> <ul style="list-style-type: none"> Do not allow them to enter the ground water, water bodies, or sewage system. Collect the used oil and dispose of it according to local environmental regulations.

**CAUTION****Danger of injury**

Prolonged contact with engine oil can lead to irritation of the skin.



- Wear safety gloves.
- If there is contact with the skin, thoroughly wash the affected areas of the skin with soap and water.

**CAUTION****Danger of injury.**

Repeated contact with diesel fuel can cause chapped and cracked skin.



- Wear safety gloves.
- If there is contact with the skin, thoroughly wash the affected areas of the skin with soap and water.

CAUTION**Danger of engine damage due to a damaged oil bath air filter**

- Do not repair the oil bath air filter (weld/solder, etc.) as this may lead to destruction of the filter or damage to the engine.

Overview

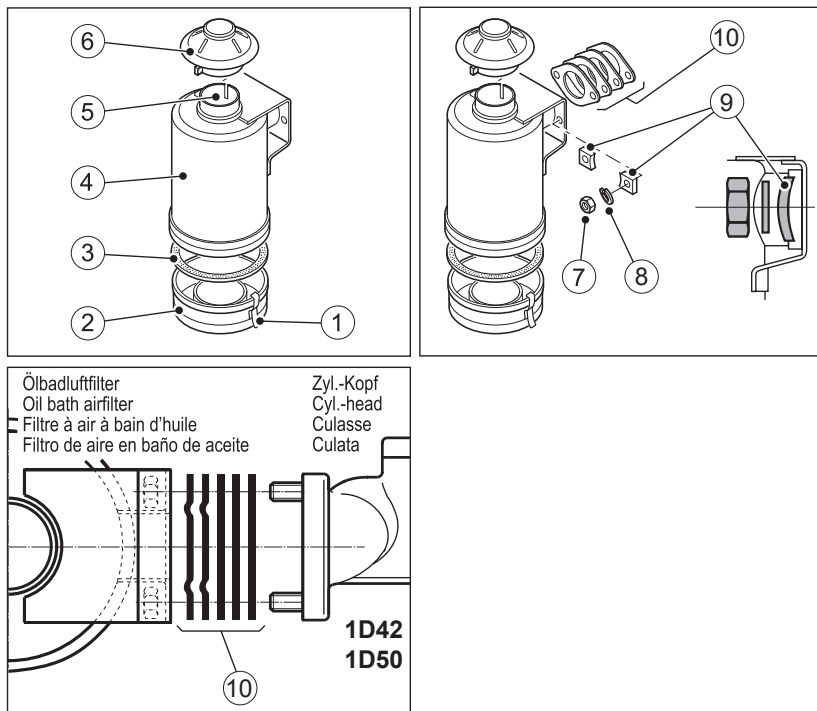

1	Clamp fastener (2x opposing)
2	Oil container
3	Gasket
4	Filter housing
5	Intake pipe
6	Rain cap
7	Fixing nut
8	Spring washer
9	Shim
10	Gasket package





Procedure

Step	Activity
1	Release the clamp fasteners (1).
2	Remove the oil container (2).

Step	Activity
3	Remove the dirty oil and sludge, and clean the container.
4	Take off and clean the rain cap (6).
5	Clean through the intake pipe (5).
6	Check the gasket (3) and renew if necessary.
7	In case of heavy contamination, remove the filter housing (4) from the engine and rinse it in diesel fuel.
8	Before assembling the filter, allow to thoroughly drip off or wipe off the diesel fuel.
9	Check the filter housing before mounting. If the sealing surface is uneven, or there are cracks in the filter housing or filter wool is missing, do not use the filter, rather replace it by a new filter.
10	Install the filter housing using a new gasket package (10). Adhere to the above sequence for engines 1D42 and 1D50 due to different gaskets (10).
11	Install the shims (9) with the curved side towards the fixing nut.
12	Fully assemble the filter and prepare it for operation by filling it with oil (see chapter 6.5 <i>Filling the oil bath air filter (option)</i> , page 35).

8.2.7 Checking and setting the tappet clearance

Safety notes

 CAUTION	
	<p>Danger of burns.</p> <p>There is a danger of burns when working on a hot engine. Only perform the settings while the engine is cold (10-30 °C).</p> <ul style="list-style-type: none"> ▪ Let the engine cool.
 CAUTION	
	<p>Damage from inadequate engine cooling.</p> <p>Only operate the engine when all covers are installed.</p>

Overview — Preparatory activities

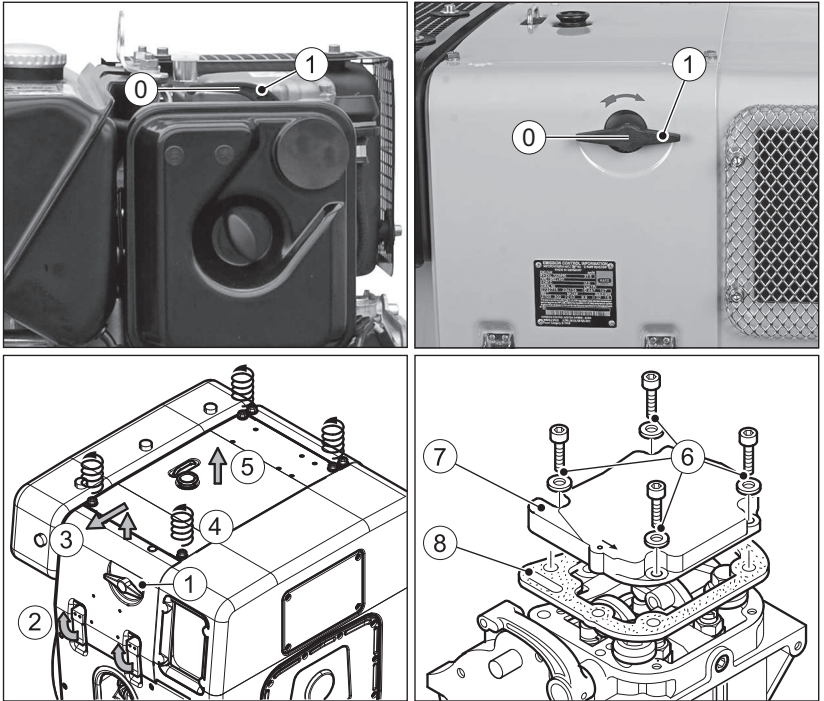

0	Position 0 (decompression lever is horizontal)
1	Decompression lever
2	Clamp fasteners
3	Side cover
4	Mounting bolt for top cover
5	Top cover
6	Mounting bolts and washers for cylinder head cover
7	Cylinder head cover
8	Gasket

Preparation

Step	Activity
1	Decompression lever is in position 0.
2	For encapsulated model : <ul style="list-style-type: none"> ▪ After releasing the clamp fasteners (2), remove the side cover (3) including the decompression lever (1). ▪ Unscrew the mounting bolts (4) and remove the top cover (5).
3	Remove dirt in the area of the cover (7).
4	Remove the mounting bolts (6).
5	Take off the cover (7) with the gasket (8). Always renew the gasket.

Overview — Adjusting the tappet clearance

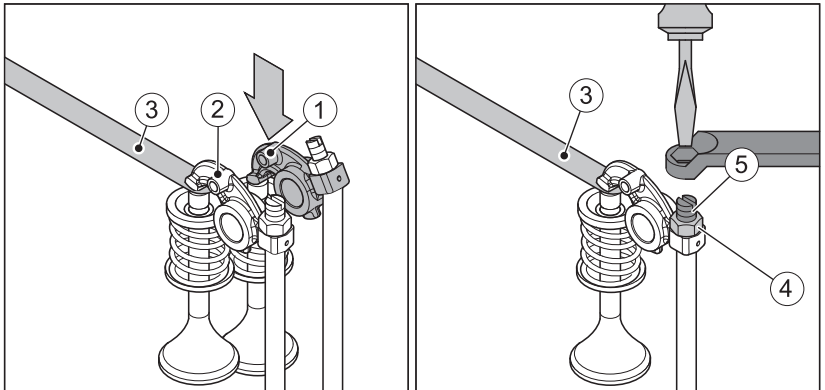

1	Rocker arm for outlet valve
2	Rocker arm for inlet valve
3	Feeler gauge
4	Hexagon nut
5	Adjusting screw





Procedure — Adjusting the tappet clearance



Step	Activity
1	Turn the engine in the sense of rotation until the rocker arm (1) has fully opened the outlet valve. Then check the tappet clearance at the rocker arm (2) with a feeler gauge (3). See chapter 4.1 <i>Engine information and filling quantities</i> , page 22 for the sense of rotation and settings.

Step	Activity
2	Turn the engine in the sense of rotation until the rocker arm (2) has fully opened the intake valve. Now check the tappet clearance at the rocker arm (1).
3	If the tappet clearance needs to be corrected: Release the hex nut (4) and turn the adjustment screw (5) so the feeler gage (3) can be pulled through with a barely perceptible resistance after the hex nut is tightened.
4	Mount the cylinder head cover with the new gasket and tighten evenly.
5	For encapsulated model : Mount the top cover. Before mounting the side cover, move the decompression lever into the horizontal position. <i>NOTE:</i> <ul style="list-style-type: none"> Under no circumstances is the engine permitted to be operated if not all covers are mounted.
6	After a brief trial run, check the cylinder head cover for tightness.

8.2.8 Cleaning the cooling air area

Safety notes

 CAUTION	
	<p>Danger of burns.</p> <p>There is a danger of burns when working on a hot engine.</p> <ul style="list-style-type: none"> Let the engine cool before maintenance.
 CAUTION	
 	<p>Danger of injury.</p> <p>When working with compressed air, foreign bodies may fly into your eyes.</p> <ul style="list-style-type: none"> Wear safety goggles. Never direct the compressed air jet toward people or toward yourself.

CAUTION	
	<p>Danger of damage to the machine from incorrect engine cleaning.</p> <ul style="list-style-type: none"> ▪ Let the engine fully cool down before cleaning. ▪ Do not spray components of the electrical equipment with a water jet or high pressure jet during cleaning.
 CAUTION	
	<p>Damage from inadequate engine cooling.</p> <p>Only operate the engine when all covers are installed.</p>
NOTICE	
	<p>In case of heavy contamination, shorten the maintenance intervals accordingly (see chapter 8.2.2 <i>Maintenance plan, page 66</i>).</p>

Procedure

Step	Activity
Dry contamination	
1	Clean the engine without using liquids and blow it out with compressed air.
Moist or oily contamination	
1	Contact HATZ service.

8.2.9 Check the screw connections

Safety note









NOTICE	
	<ul style="list-style-type: none"> ▪ Do not retighten the screws for attaching the cylinder head. ▪ The adjustment screws on the speed governor and the injection system are secured with locking varnish and are not permitted to be tightened or adjusted. ▪ Only retighten loose screw connections. Screw connections can be secured with thread locking adhesive or tightened to a defined torque. Retightening tight screw connections can cause damage.

Procedure

Step	Activity
1	Check the condition of all screw connections and ensure that they are tight (for exceptions, see note).
2	Tighten any loose screw connections.

8.2.10 Changing the fuel filter

Safety notes

 DANGER	
 	<p>Fire hazard from fuel</p> <p>Leaked or spilled fuel can ignite on hot engine parts and cause serious burn injuries.</p> <ul style="list-style-type: none"> ▪ Do not spill fuel. ▪ No open flames when working on the fuel system. ▪ Do not smoke.
 CAUTION	
 	<p>Danger of burns.</p> <p>There is a danger of burns when working on a hot engine.</p> <ul style="list-style-type: none"> ▪ Let the engine cool. ▪ Wear safety gloves.
 CAUTION	
 	<p>Danger of injury.</p> <p>Repeated contact with diesel fuel can cause chapped and cracked skin.</p> <ul style="list-style-type: none"> ▪ Wear safety gloves. ▪ If there is contact with the skin, thoroughly wash the affected areas of the skin with soap and water.

**CAUTION****Danger of environmental damage from spilled fuel.**

When the filter is removed, a small amount of fuel is drained as well.

- Collect any escaping fuel and dispose of it according to local environmental regulations.

CAUTION**Dirt particles can damage the injection system.**

- Maintain clean conditions to ensure dirt does not enter the fuel line.

Procedure



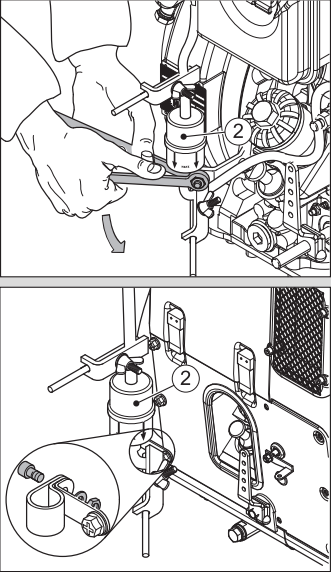
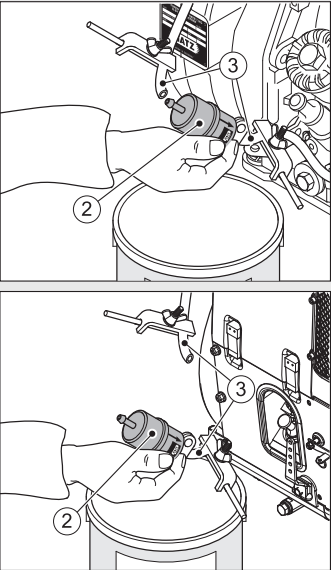

Step	Activity	Figure
1	Close the fuel feed line before and after the fuel filter , see pos. 1.	

Step	Activity	Figure
2	Unscrew the fuel filter (2) from the holder.	
3	<ul style="list-style-type: none"> ▪ Place a suitable container under the fuel filter to collect emerging fuel. ▪ Pull the fuel line (3) off the fuel filter (2) on both sides, and insert a new filter. Observe the flow-through direction (arrows). 	
4	Attach the fuel filter to the holder.	
5	Check the fuel flow, if necessary pre-pump fuel.	

Step	Activity	Figure
6	Activate the mechanical oil pressure shut down device (option) (see chapter 7.3.2 <i>Activating the mechanical oil pressure shut down device (option)</i> .; page 39).	
7	Check the fuel filter and lines for tightness after a brief trial run.	

8.2.11 Maintaining the dry air filter

Safety notes

 CAUTION	
 	<p>Danger of burns.</p> <p>There is a danger of burns when working on a hot engine.</p> <ul style="list-style-type: none"> Wear safety gloves.
NOTICE	
	<ul style="list-style-type: none"> Immediately clean the filter cartridge if the maintenance display appears at maximum speed. Always renew the filter cartridge after a use period of 500 operating hours.

Preparation – Encapsulated model 1D81C, 1D90C

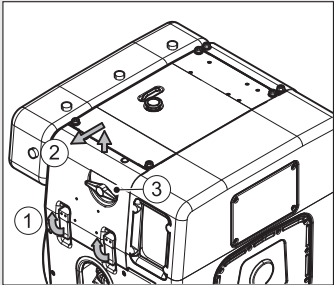
Step	Activity	Figure
1	After releasing the clamp fasteners (1), remove the side cover (2) including the decompression lever (3).	



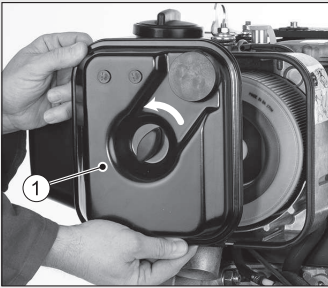
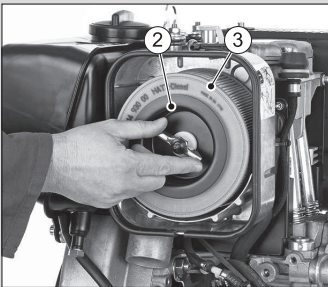
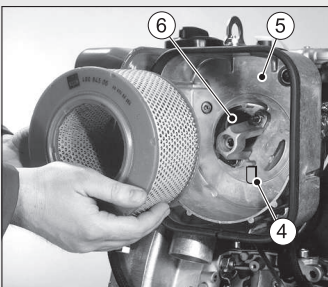
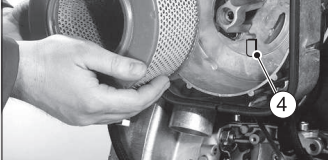

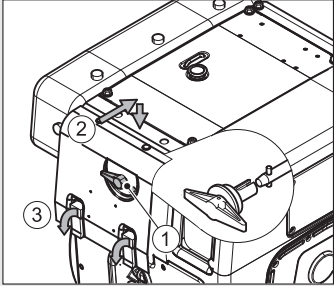

Procedure

Step	Activity	Figure
1	Unscrew the air filter cover (1).	
2	Unscrew the fixing (2) and remove the air filter cartridge (3).	
3	In the model with an air filter maintenance display, check the condition and cleanliness of the valve shim (4).	
4	Clean the filter housing (5) and cover for the air filter. Ingress of dirt or other foreign bodies into the intake opening (6) must be absolutely avoided.	
5	The air filter cartridge either needs to be replaced, or cleaned or checked depending on the degree of contamination (see chapter 8.2.12 <i>Checking and cleaning the air filter cartridge</i> , page 89).	
6	Assemble in reverse order.	

Step	Activity	Figure
7	<p>For encapsulated model:</p> <p>Before mounting the side cover, move the decompression lever (1) into the horizontal position. Then mount the cover in the sequence 2..3.</p> <p>NOTE:</p> <ul style="list-style-type: none"> Under no circumstances is the engine permitted to be operated if not all covers are mounted. 	

8.2.12 Checking and cleaning the air filter cartridge

Safety notes

 CAUTION	
 	<p>Danger of injury.</p> <p>When working with compressed air, foreign bodies may fly into your eyes.</p> <ul style="list-style-type: none"> Wear safety goggles. Never direct the compressed air jet toward people or toward yourself.
 CAUTION	
	<p>Danger of injury.</p> <p>When blowing out the filter cartridge, the ambient air becomes contaminated with dust.</p> <ul style="list-style-type: none"> This dust may contain harmful particles. Wear a fine dust mask.
NOTICE	
	<ul style="list-style-type: none"> The pressure must not exceed 5 bar. A distance of approx. 150 mm must be maintained between the filter cartridge and the compressed air gun. The filter cartridge may not be washed out or beaten out. Even minor damage in the areas of the sealing surface, filter paper or filter cartridge makes it impossible to reuse the filter cartridge.

Overview

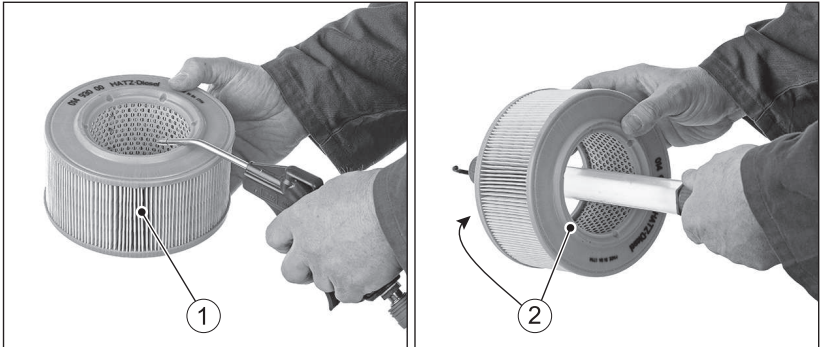

1	Air filter cartridge
2	Sealing surfaces

Procedure

Step	Activity
Dry contamination	
1	Blow out the filter cartridge with dry compressed air from the inside to the outside until dust no longer emerges.
2	Check the sealing surfaces (2) of the filter cartridge for damage.
3	Check the filter cartridge for cracks in the filter paper and other damage by holding it against the light at a slant or letting light from a lamp shine through it.
4	Replace the filter cartridge if necessary (see note).
Moist or oily contamination	
1	Renew the filter cartridge.

9 Faults

9.1 Troubleshooting

General troubleshooting notes

If the cases listed below have been worked through but the fault continues to persist, please contact your nearest **Hatz service station**.

The engine does not start or is difficult to start, but can be turned easily as usual

Possible causes	Remedy	Chapter
Speed control lever in stop or idle position.	Set the speed control lever to the START position.	<i>7.3.3 Setting the speed control, page 42</i>
Stop lever in STOP position.	Set the lever to the "START" operating position.	<i>7.5.1 Switching off the engine (mechanical), page 52</i>
No fuel at the injection pump.	Refuel.	<i>7.7 Refueling, page 58</i>
	Actuate the fuel feed pump (option).	
	Activating the mechanical oil pressure shut down device (option).	<i>7.3.2 Activating the mechanical oil pressure shut down device (option);, page 39</i>
	Systematically check the entire fuel supply. If this does not yield results:	
	▪ Check the feed line to the engine.	
	▪ Check the fuel filter.	<i>8.2.10 Changing the fuel filter, page 84</i>
Injection nozzle is not functional.	Contact HATZ Service.	
Insufficient compression:		
▪ Wrong tappet clearance.	Check the tappet clearance and adjust if necessary.	<i>8.2.7 Checking and setting the tappet clearance, page 79</i>
▪ Cylinder and/or piston ring wear.	Contact HATZ Service.	

If equipped with mechanical oil pressure shut down device (engine does not start)

Possible causes	Remedy	Chapter
No oil pressure.	Check the oil level.	<i>7.6 Check the oil level, page 54</i>
	Activate the mechanical oil pressure shut down device.	<i>7.3.2 Activating the mechanical oil pressure shut down device (option).; page 39</i>

At low temperatures (engine does not start)

Possible causes	Remedy	Chapter
Temperature below start limit temperature.	Activate the pre glow system (option).	<i>7.4.3 Starting the engine with a starter, page 48</i>
Pre glow system (option) defective.	Contact HATZ Service.	
Fuel gelled due to insufficient cold resistance.	Check whether the fuel that emerges from the fuel feed line is clear and not cloudy. If the fuel has gelled, either thaw the engine or drain the entire fuel supply system. Fill with a temperature-resistant fuel mixture.	<i>4.5 Fuel, page 26</i> <i>8.2.10 Changing the fuel filter, page 84</i>
Oil is too viscous and causes a too low starter speed.	Change the engine oil. Add engine oil with a suitable viscosity class.	<i>8.2.5 Changing the engine oil and oil filter, page 71</i>
Insufficiently charged battery.	Check the battery and contact the service center if necessary.	<i>3.2.4 Electrical equipment, page 18</i>
Machine is not uncoupled.	If possible, separate the engine from the machine by uncoupling it.	

The starter does not switch on and the engine does not turn.

Possible causes	Remedy	Chapter
Irregularities in the electrical equipment:		
Battery and/or other cable connections are incorrectly connected.	Check the electrical equipment and its components or contact Hatz service.	<i>3.2.4 Electrical equipment, page 18</i>
Cable connections are loose and/or oxidized.		
Battery is defective and/or not loaded.		
Defective starter.		
Defective relay, monitoring elements etc.		

The engine fires but then fails to continue running

Possible causes	Remedy	Chapter
The speed control lever is not sufficiently set to the Start direction.	Set the lever to the Start position.	<i>7.3.3 Setting the speed control, page 42</i>
Machine is not uncoupled.	If possible, separate the engine from the machine by uncoupling it.	
Fuel filter is clogged.	Change the fuel filter.	<i>8.2.10 Changing the fuel filter, page 84</i>
Fuel supply is interrupted.	Systematically check the entire fuel supply.	
Stop signal from monitoring elements that are associated with the automatic electrical switch-off mechanism (optional):		
▪ No oil pressure.	Check the oil level.	<i>7.6 Check the oil level, page 54</i>
▪ Faults in the AC alternator or alternator charging circuit.	Contact HATZ Service.	
▪ Engine temperature too high.	Check the cooling air guides for contamination or other impairments.	<i>8.2.8 Cleaning the cooling air area, page 82</i>

Possible causes	Remedy	Chapter
Fault signal from the overvoltage and polarity protection system in the voltage regulator:		
Battery and/or other cable connections are incorrectly connected.	Check the electrical equipment and its components or contact Hatz service.	3.2.4 <i>Electrical equipment, page 18</i>
Loose cable connections.		

Engine switches off spontaneously during operation

Possible causes	Remedy	Chapter
The tank ran out of fuel during operation.	Fill with fuel.	7.7 <i>Refueling, page 58</i>
Fuel filter is clogged.	Change the fuel filter.	8.2.10 <i>Changing the fuel filter, page 84</i>
Mechanical oil pressure shut down device switches off the engine due to oil pressure loss.	Check the oil level.	7.6 <i>Check the oil level, page 54</i>
	Activate the mechanical oil pressure shut down device.	7.3.2 <i>Activating the mechanical oil pressure shut down device (option).; page 39</i>
Air in the fuel system.	Check the fuel system for air ingress. Check the bleed valve.	
Mechanical faults.	Contact HATZ Service.	

With automatic electrical switch-off mechanism (option)

Possible causes	Remedy	Chapter
Stop signal of monitoring elements for:		
▪ No oil pressure.	Check the oil level.	<i>7.6 Check the oil level, page 54</i>
▪ Faults in the AC alternator or alternator charging circuit.	Contact HATZ Service.	
▪ Engine temperature too high.	Check the cooling air guides for contamination or other impairments.	<i>8.2.8 Cleaning the cooling air area, page 82</i>
Fault signal from the overvoltage and polarity protection system in the voltage regulator:		
Battery and/or other cable connections are incorrectly connected.	Check the electrical equipment and its components or contact Hatz service.	<i>3.2.4 Electrical equipment, page 18</i>
Loose cable connections.		

The engine loses power and speed

Possible causes	Remedy	Chapter
The speed adjustment lever does not stay in the desired position.	Block the speed adjustment.	
The fuel supply is impaired:		
▪ The tank ran out of fuel during operation.	Add fuel.	<i>7.7 Refueling, page 58</i>
▪ Fuel filter is clogged.	Change the fuel filter.	<i>8.2.10 Changing the fuel filter, page 84</i>
▪ Inadequate tank venting.	Ensure that the tank is sufficiently vented.	
▪ Air in the fuel system.	Check the fuel system for air ingress. Check the bleed valve.	

The engine loses power and speed, and black smoke emerges from the exhaust

Possible causes	Remedy	Chapter
Dirty air filter unit.	Check the degree of dirt contamination of the air filter, and clean or renew if necessary.	8.2.11 <i>Maintaining the dry air filter, page 87</i>
Tappet clearance not OK.	Adjust the tappet clearance.	8.2.7 <i>Checking and setting the tappet clearance, page 79</i>
Injection nozzle not OK.	Contact HATZ Service.	

Engine becomes very hot. Indicator lamp for engine temperature (option) lights up

Possible causes	Remedy	Chapter
Too much engine oil in the engine.	Drain the engine oil to the upper mark of the dipstick.	7.6 <i>Check the oil level, page 54</i>
Inadequate cooling:		
<ul style="list-style-type: none"> ▪ Contamination in the entire area of the cooling air guides. 	Clean the cooling air area.	8.2.8 <i>Cleaning the cooling air area, page 82</i>
<ul style="list-style-type: none"> ▪ Incompletely closed air guide parts. 	Check the air guide parts and shafts for completeness and good sealing properties.	

10 Storage and disposal

10.1 Storing the machine

Safety notes



DANGER



Danger to life from inhaling exhaust gases.

Toxic engine exhaust gases can lead to loss of consciousness, and even death, in closed-off and poorly ventilated rooms.

- Never operate the machine in closed-off or poorly ventilated rooms.
- Do not breathe in the exhaust gases.



DANGER



Fire hazard from fuel.

Leaked or spilled fuel can ignite on hot engine parts and cause serious burn injuries.

- Only refuel when the engine is switched off and has cooled down.
- Never refuel in the vicinity of open flames or sparks that can cause ignition.
- Do not smoke.
- Do not spill fuel.



CAUTION



Danger of environmental damage from spilled fuel.

Do not overfill the fuel tank and do not spill fuel.

- Collect any leaking fuel and dispose of it according to local environmental regulations.

NOTICE



Comply with the safety chapter!

Follow the basic safety instructions in chapter 3 *Safety*, page 7.

Storing the machine for a lengthy period

Take the following measures if you intend to take the machine out of service for a lengthy period (3-12 months):

Step	Activity
1	Drain the fuel tank until it is nearly empty and fill with FAME*-free fuel. Operate the engine for a few minutes so that only FAME-free fuel is still in the fuel system.
2	Change the engine oil and oil filter (see chapter 8.2.5 <i>Changing the engine oil and oil filter</i> , page 71).
3	Change the fuel filter (see chapter 8.2.10 <i>Changing the fuel filter</i> , page 84).
4	Let the machine cool down.
5	Remove the battery in accordance with the Operator's Manual for the machine and store at ambient temperature. Comply with the local regulations as well as the regulations of the battery manufacturer for the storage of batteries.
6	Close and seal all engine openings (air intake openings, air outlet openings and the exhaust gas opening) so that no foreign bodies can enter, but a small amount of air can still be exchanged. This avoids condensation.
7	After the machine has cooled down, cover it to protect it against dust, and store it in a dry and clean place.

*FAME = Fatty Acid Methyl Ester

Ambient conditions during storage

- Max. permissible storage temperature: -25 °C to +60 °C
- Max. permissible humidity: 70%
- Protect the engine from direct sunlight

Recommissioning

Step	Activity
1	Remove all covers.
2	Check the cables, hoses and lines for cracks and leak tightness.
3	Check the engine oil level.
4	Install the battery in accordance with the Operator's Manual for the machine.

The brand new engine can normally be stored for up to 12 months. The protection lasts up to approx. 6 months at very high humidity and in sea air.

For storage periods of more than 12 months, please contact the nearest **HATZ Service**.

10.2 Disposing of the machine

Disposal information

Dispose of the machine (including machine parts, engine oil and fuel) according to the local disposal regulations and the environmental laws in the country of use.

Because of the danger of possible environmental damage, only permit an approved specialist company to dispose of the machine.

NOTICE



When the machine has reached the end of its lifecycle, ensure that it is disposed of safely and properly, especially parts and substances that can be dangerous to the environment. These also include fuel, lubricants, plastics, and batteries (if present).

- Do not dispose of the battery with the household trash.
- Dispose of the battery at a collection point for possible recycling.

11 Declaration of incorporation

Extended Declaration of Incorporation EC Machinery Directive 2006/42/EC

The manufacturer: **Motorenfabrik Hatz GmbH & Co.KG**
Ernst-Hatz-Straße 16
94099 Ruhstorf a. d. Rott (Germany)

hereby declares that the incomplete machine: product description: **Hatz diesel engine**

Type designation and as of serial number:

1D42=13311; 1D42=15510; 1D50=10920;
1D50=15610; 1D81=07327; 1D81=17927;
1D81C=18027; 1D90=10820; 1D90E=18505
1D90V/W=11317; 1D90V/W=18117

satisfies the following basic safety and health protection requirements in acc. with Annex I to the above-mentioned Directive.

- General principles no. 1

- Nr. 1.1.2., 1.1.3., 1.1.5., 1.2.1., 1.2.2., 1.2.3., 1.2.4.1., 1.2.4.2., 1.2.6, 1.3.1., 1.3.2., 1.3.3., 1.3.4., 1.3.7., 1.3.9., 1.4.1., 1.5.1., 1.5.3., 1.5.8., 1.5.9., 1.5.10, 1.5.11, 1.6.1., 1.6.2., 1.6.4., 1.7.

All relevant basic safety and health protection requirements down to the interfaces described

- in the manual for diesel engine
- in the enclosed data sheets
- in the enclosed technical documents

have been complied with.

The following standards have been applied (fully or in part):

- EN 1679-1: 092011 - EN ISO 12100: 032011 - EN ISO 13857: 062008
 - EN 60204-1:062007

The manual for the diesel engine has been attached to that of the incomplete machine and the Assembly Instructions have been provided to the customer electronically together with the order confirmation.

The special technical documents in acc. with Annex VII B of the Directive 2006/42/EC have been prepared. If necessary, I will submit the above-mentioned special technical documents in electronic form to the competent authority.

The above-mentioned special technical documents can be requested from:
 Wolfgang Krautloher, address, see manufacturer

Commissioning is prohibited until it has been established, where applicable, that the machine into which the above-mentioned incomplete machine is to be incorporated, satisfies the provisions of the Machinery Directive.

19/10/2021

Date

 Maximilian Eder

Series manager air-cooled engines



Dr.-Ing. Simon Thierfelder
 Chief Technical Officer - CTO

12 Declaration of the manufacturer

The following "Manufacturer's declaration of compliance with regulation (EU) 2016/1628" only applies to engines with an engine family designation in accordance with chapter 1.5 (see next page).

The corresponding engine family designation is noted on the engine type plate (see chapter 4.2 *Engine type plate*, page 23).

CO₂ emissions*

Engine family designation	CO ₂ g/kWh	Test cycle	Parent engine	Speed
1D42/50-cs	1020.16	NRSC-D2	1D50	3000
1D42/50-vs	993.78	NRSC-G2	1D50	3000
1D81/90-cs	987.94	NRSC-D2	1D90	3000
1D81/90-vs	974.76	NRSC-G2	1D90	3000

*According to EU Regulation 2016/1628, Article 43 Paragraph (4)

Declaration by manufacturer on compliance with Regulation (EU) 2016/1628

The undersigned: Manfred Wührmüller, Head of Quality Management GMQ

Hereby declares that the following engine type/engine family (*) complies in all respects with the requirements of Regulation (EU) 2016/1628 of the European Parliament and of the Council ⁽¹⁾, Commission Delegated Regulation (EU) 2017/654 ⁽²⁾, Commission Delegated Regulation (EU) 2017/655 ⁽³⁾ and Commission Implementing Regulation (EU) 2017/656 ⁽⁴⁾ and does not use any defeat strategy.

All emission control strategies comply, where applicable, with the requirements for Base Emission Control Strategy (BECS) and Auxiliary Emission Control Strategy (AECS) set-out in section 2 of Annex IV to Delegated Regulation (EU) 2017/654, and have been disclosed in accordance with that Annex and with Annex I to Implementing Regulation (EU) 2017/656.

- 1.1. Make (trade name(s) of manufacturer): **Hatz**
- 1.2. Commercial name(s) (if applicable): **Hatz-Diesel**
- 1.3. Company name and address of manufacturer:
Motorenfabrik Hatz GmbH & Co. KG, Ernst-Hatz-Str. 16, 94099 Ruhstorf a.d. Rott
- 1.4. Name and address of manufacturer's authorised representative (if any): –
- 1.5. Engine type designation/ engine family designation/ FT (*): **1D42/50-vs, 1D42/50-cs, 1D81/90-vs, 1D81/90-cs**

(Place) (Date):

Ruhstorf a.d.R. 04.07.18

⁽¹⁾ Regulation (EU) 2016/1628 of the European Parliament and of the Council of 14 September 2016 on requirements relating to gaseous and particulate pollutant emission limits and type-approval for internal combustion engines for non-road mobile machinery, amending Regulations (EU) No 1024/2012 and (EU) No 167/2013, and amending and repealing Directive 97/68/EC (OJ L 252, 16.9.2016, p. 53).

⁽²⁾ Commission Delegated Regulation (EU) 2017/654 of 19 December 2016 supplementing Regulation (EU) 2016/1628 of the European Parliament and of the Council with regard to technical and general requirements relating to emission limits and type-approval for internal combustion engines for non-road mobile machinery (OJ L 102, 13.4.2017, p. 1).

⁽³⁾ Commission Delegated Regulation (EU) 2017/655 of 19 December 2016 supplementing Regulation (EU) 2016/1628 of the European Parliament and of the Council with regard to monitoring of gaseous pollutant emissions from in-service internal combustion engines installed in non-road mobile machinery (OJ L 102, 13.4.2017, p. 334).

⁽⁴⁾ Commission Implementing Regulation (EU) 2017/656 of 19 December 2016 laying down the administrative requirements relating to emission limits and type-approval of internal combustion engines for non-road mobile machinery in accordance with Regulation (EU) 2016/1628 of the European Parliament and of the Council (OJ L 102, 13.4.2017, p. 364).

⁽⁵⁾ Regulation (EU) No 910/2014 of the European Parliament and of the Council of 23 July 2014 on electronic identification and trust services for electronic transactions in the internal market and repealing Directive 1999/93/EC (OJ L 257, 28.8.2014, p. 73).

Motorenfabrik Hatz GmbH & Co. KG

Ernst-Hatz-Str. 16

94099 Ruhstorf a. d. Rott

Deutschland

Tel. +49 8531 319-0

Fax. +49 8531 319-418

marketing@hatz-diesel.de

www.hatz-diesel.com



CREATING POWER SOLUTIONS.

0000 433 202 18 - 10.2023

Printed in Germany

ENG